



**Simply Better**

# **Underlays & Accessories Directory**

**Issue 24**



**Simply Better**

# WELCOME TO QA

**QA FLOORING SOLUTIONS  
IS ONE OF THE WORLD'S  
LEADING MANUFACTURERS  
AND DISTRIBUTORS OF  
LVT FLOORING, UNDERLAY  
AND ACCESSORIES.**

In the UK, we operate a large distribution centre with capacity to provide next day delivery if required.

Our growth has been achieved through our relentless focus to be 'Simply Better' than our competitors by producing innovative and highly desirable products, delivering world class service and critically, selling products that suit every application and budget.

Keeping it simple. Always being better... That's what QA is all about.

## **The QA Team**

Contact us for fantastic prices on:  
Wood Underlays, Carpet Underlays, Acoustic Systems, Gripper,  
Profiles, Adhesives, Scotia and Tapes

**Tel: 0151 495 3434 or Email: [sales@qaflooringsolutions.com](mailto:sales@qaflooringsolutions.com)**



Simply Better

# CONTENTS

- 2 Welcome To QA
- 3 Contents
- 4 6 Great Reasons
- 5 How To Order
- 6 Online Ordering
- 8 Our Warranty
- 9 Where We Are
- 10 Marketing Support
- 11 Traffilay System
- 12 Retail Display Solutions

## Underlays

- 16 Wood Underlay Introduction
- 18 Wood Underlays
- 39 Wood Underlay Technical Information
- 40 Carpet Underlay Introduction
- 42 Carpet Underlays
- 63 Carpet Underlay Technical Information
- 64 Acoustic Solutions Introduction
- 66 Acoustic Solutions
- 75 Acoustic Solutions Technical Information

## Floor Levelling Systems

- 76 Jumpax Basic
- 78 Flooring Grade Plywood

## Accessories

- 80 Accessories Introduction
- 82 Standard Profiles
- 85 Self Adhesive Profiles
- 88 Specialist Profiles
- 94 Premium Profile
- 97 Scotia Beading
- 99 Standard Gripper
- 100 Premium Gripper
- 101 Deep Base Gripper
- 102 Adhesives
- 103 Tapes
- 105 Tools
- 106 Polythene
- 107 Packaging



# QA

Simply Better

# 6 GREAT REASONS TO LOVE QA



For all orders over **£400.00 + VAT** free delivery is available.



Our huge range makes sourcing all your flooring needs easy! With our products in stock we're the perfect single source partner.



**NEXT DAY DELIVERY** available on request.



If there's anything you're not happy with - we'll put it right. **QUICKLY, HONESTLY AND GENEROUSLY.**

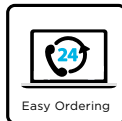

Whether it be phone, online or email, our service is geared to your convenience the moment you make contact - **EXPERIENCE IT TODAY!**



One of the biggest stock holdings of underlay and accessories in the UK.



Simply Better

# HOW TO ORDER



**0151 495 3434**



**sales@qaflooringsolutions.com**



**0151 427 0484**



**www.qaflooringsolutions.com**

All orders are accepted subject to our Terms and Conditions of Sale - a copy of these is available on request.

## Our Delivery Service

We offer a standard 2-3 day delivery service with next day delivery available if required. We also offer a range of delivery options, from timed deliveries to home address and site drops so you can be sure that you get your goods on time!

## Delivery Options

- **Standard delivery (2-3 days) FREE over £400**
- **Below minimum order value £30**
- **Next day delivery £35**
- **Delivery to building site / home address £48**
- **AM / before 12pm £50**
- **Saturday / same day P.O.A.**
- **Outside mainland UK / export P.O.A.**

Delivery cost correct at time of print and may be subject to change.

## ★ REVIEWS WHAT DO OUR CUSTOMERS SAY?

'I've been a customer of QA's since I started my business 10 years ago, the reps really know their stuff and look after me whatever it is I need. The office staff are helpful and always ready to assist by phone or email. A really solid family-owned business offering quality products at competitive prices.'

**Carpet Wholesaler, Yorkshire**

'QA does such a wide range of flooring products, from underlays to profiles, different types of gripper and even acoustics. QA is my go-to supplier, and the new trade portal makes ordering really quick and easy to view the whole range they offer and my special prices, I can order any time of day.'

**Flooring Wholesaler, South West**

'Outstanding service! QA staff are very quick to respond, queries are resolved straight away by one of the friendly team. Highly recommended!'

**Flooring Retailer, North West**





# ONLINE ORDERING



You can now order online at our trade only portal which can be found at: [trade.qaflooringsolutions.com](https://trade.qaflooringsolutions.com)

Contact your Account Manager to get set up today!



# BENEFITS OF ORDERING ONLINE

Order at your convenience using our online portal and you can...

- ✓ Check current stock levels and your bespoke prices so you can plan your jobs with confidence
- ✓ Quickly re-order frequently purchased products by accessing them through your Saved Items
- ✓ Access your invoices, credit details and other accounting information
- ✓ View technical data / COSHH sheets and instruction documents

**Order ONLINE NOW through our trade portal.  
[trade.qaflooringsolutions.com](https://trade.qaflooringsolutions.com)**

Speak to your Account Manager or contact 0151 495 3434 to gain access to our online portal





Simply Better

# OUR WARRANTY

**IF THERE'S ANYTHING YOU'RE NOT HAPPY WITH - WE'LL PUT IT RIGHT. QUICKLY, HONESTLY AND GENEROUSLY.**



No hassle. No unanswered calls. No loose ends. You simply want to know you can trust the products and people you're dealing with. After all, it could be your trade reputation at stake - or the comfort of your home.

With QA, you can expect guaranteed reliability - every time.

When we say we offer you a complete flooring solution, we mean it, and we'll go the extra mile to make sure you're happy with every aspect of our service.

And even though we've got over 2000 product options, whatever you get from us is covered by one straightforward warranty.

Please Note: All product images contained within this directory are for representative purpose only and the appearance of the actual products may vary due to the nature of the raw materials used in the manufacturing process.





Simply Better

# WHERE WE ARE



**IN THE UK, WE OPERATE FROM A LARGE DISTRIBUTION CENTRE, A SHORT DISTANCE FROM OUR HEAD OFFICE IN LIVERPOOL, COVERING THE WHOLE OF THE UK AND REPUBLIC OF IRELAND.**



# QA

Simply Better

# MARKETING SUPPORT

WE OFFER A WIDE RANGE  
OF POS TO HELP INCREASE  
YOUR SALES, INCLUDING:

- Product Directories
- Sample Boards
- Hanging Samples
- Sample Books
- Profile Stands
- Retail Sample Display Stands

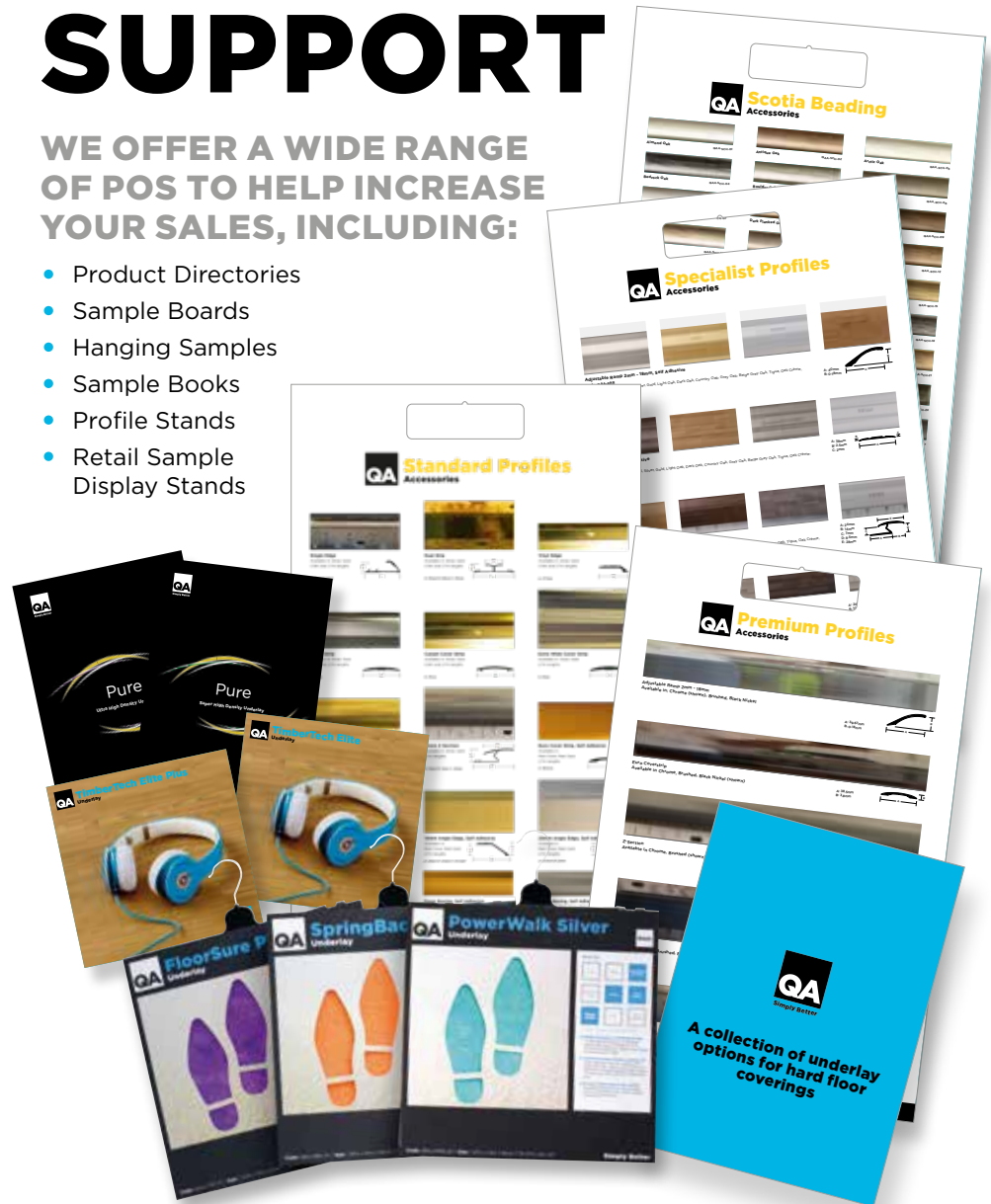



# TRAFFILAY

**A SIMPLY BETTER WAY TO FIND YOUR PERFECT UNDERLAY.**

## How Traffilay works

Having decided on your floor covering (wood, carpet, etc) think about the foot traffic the room or area usually receives. For example, bedrooms are typically light traffic, living rooms usually medium, and hallways and kitchens would be considered heavy foot traffic areas.

Then choose the features and benefits you want most - like cushioning, durability or insulation.

Finally, from your shortlist of suitable underlays, decide which is closest to what you need.

## In the brochure

Our products are arranged by type of floor covering and the recommended traffic level.

The main features and benefits will be highlighted in the top squares next to each product. The additional benefits or suitability of the product will be represented by the bottom squares. This will help you make the best selection that meets your needs.

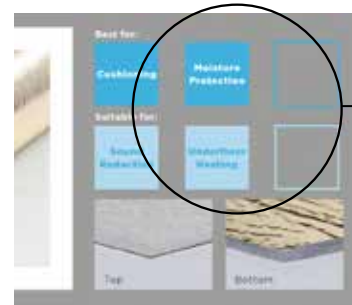

Looks for the features to help you make the right choice for your needs.

## Recycled, Recyclable and Eco-Friendly

Look out for these symbols on our eco-friendly products.





**Underlays &  
Accessories**

# RETAIL DISPLAY SOLUTIONS

CARPET & WOOD UNDERLAYS, PROFILES & ACCESSORIES

## Sample Display Free Standing Tower



Complete  
with a Range  
of FREE  
Samples

Dimension: 1800mm Height x 1080mm Width (including arms) x 500mm Depth

**Can be supplied with or without lightbox**

Comes complete with all hanging arms, profile sample display boards, literature holders (x2), carpet and wood underlay sample swatches

**£950 + VAT**  
(£1,200 with lightbox)



# Underlays & Accessories

## Sample Display Slat Wall Panel



Complete with a Range of FREE Samples

Dimension: 1200mm Height x 1200mm Width x 175mm Depth (with display shelf)

### Wall Hanging (must be fixed to wall)

**Keep all your QA Underlay & Accessories samples in one easy to view display**

Comes complete with all hanging arms, literature holder, sample display shelf, profile sample display boards, carpet and wood underlay sample swatches

## £350 + VAT

A free standing version of the slat wall display is also available for £550 + VAT





# Underlays & Accessories

## Specialist Profile Retail Display Stands



Dimension:  
Height: 2.01m / Width: 0.625m / Depth: 0.62m  
33 Hooks  
Approx. 10 Lengths per Hook



Dimension:  
Height: 3.16m / Width: 0.63m / Depth: 0.62m  
18 Hooks  
Holds 10-15 Tubes

**FREE Stand with First 30 Tubes of Profiles Purchased (Any combination)**



Simply Better

# Matt Black Profiles

An attractive collection of popular profiles in a stylish matt black finish.



See pages 82-95 for our full collection of profiles.



The logo consists of the letters 'QA' in a bold, white, sans-serif font, set against a solid black square background.

**Simply Better**

# Wood Underlays

**At the heart of any complete flooring solution is the underlay. We should know - we sell millions of square metres every year! In this section you will find all you need to know about our underlay options for wood and laminate floors.**



## Traffily Group

### Light Traffic

	Cushioning	Level Floors	Hard Wearing	Moisture Protection	Compression Recovery	Heat Insulation	Sound Reduction	Underfloor Heating	Commercial Use	Page No
UniBase Bronze	■						■	■		18
AWC15	■						■	■		18
UniBase Silver	■			■			■	■		18
UniBase Gold	■			■			■	■		18
Silver Lux	■			■			■	■		20

### Medium Traffic

Barrier	■			■			■	■		22
Barrier Plus	■			■			■	■		22
ProTech	■			■			■	■		24
FibreBoard		■				■	■			26
TechniBoard		■				■	■			26
QuickTherm			■				■	■		28
QuickTherm Vapour				■			■	■		28

### Heavy Traffic

TimberTech Elite			■	■	■		■	■	■	30
TimberTech Elite Plus			■	■	■		■	■	■	30
TimberTech Neo			■	■			■	■		32
TimberTech Neo Acoustic		■	■	■			■	■		32
TimberTech2 Silver			■	■	■		■	■		34
TimberTech2 Silver Plus			■	■	■		■	■		34
TimberTech2 Gold			■	■			■	■	■	36
TimberTech2 Acoustic Plus		■	■	■			■	■	■	36





Light  
Traffic



100% recyclable PE foam  
**wood underlays for light traffic**  
offering terrific value.

Suitable for use with laminate and engineered wood flooring (floating floor installation).

### **Longer-lasting flooring**

UniBase gives your floor covering the perfect level of support to protect it from excess wear and even high impact damage - all of which helps your floor look good for longer!

### **Lightening the load**

The ultra lightweight polyethylene foam material makes UniBase so easy to lift and manoeuvre... you won't believe just how much time and effort that can save you on every installation.

### **Protects against damp**

Don't worry about moisture rising up from the sub-floor - UniBase Silver and UniBase Gold have the added benefit of a metallised vapour barrier that overlaps and protects your floor covering and keeps your room dry as a bone.

Made with 100% recyclable polyethylene foam.





## UniBase Bronze Underlay



Available in

Code	Size	Thickness	Pallet QTY
QAU-UBB-02	1m x 15m (15m <sup>2</sup> )	2mm	70
QAU-UBB-03	1m x 15m (15m <sup>2</sup> )	3mm	50
QAU-UBB-05	1m x 120m (120m <sup>2</sup> )	2mm	8
AWC15 (not pictured)	1m x 15m (15m <sup>2</sup> )	2.5mm + overlap	50

Best for:

Cushioning

Suitable for:

Sound Reduction

Underfloor Heating



## UniBase Silver Underlay



Available in

Code	Size	Thickness	Pallet QTY
QAU-UBS-02	1m x 15m (15m <sup>2</sup> )	2mm	70

Best for:

Cushioning

Moisture Protection

Suitable for:

Sound Reduction

Underfloor Heating

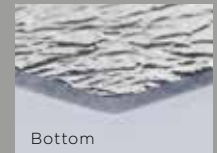
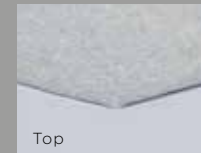

## UniBase Gold Underlay



Available in

Code	Size	Thickness	Pallet QTY
QAU-UBG-01	1m x 10m (10m <sup>2</sup> )	3mm + Overlap and s/a strip	80

Best for:

Cushioning

Moisture Protection

Suitable for:

Sound Reduction

Underfloor Heating





Light  
Traffic



**Silver Lux**  
Underlay

**Great value** 100% recyclable PE foam wood underlay with **moisture protection overlap**.

### **Protects against moisture**

Silver Lux gives reliable protection against moisture rising from the sub-floor, keeping your floor dry.

### **Faster and cleaner fitting**

There's no wasting time with Silver Lux – it's not only lightweight to lift and move around, but really easy to cut and install so you can get on with the job.

Silver Lux gives you less clearing up to do afterwards, as it's dust free and so cleaner and easier to install.

Made with 100% recyclable polyethylene foam.





# Silver Lux Underlay



Available in

Code	Size	Thickness	Pallet QTY
SL15	1m x 15m (15m <sup>2</sup> )	3mm + Overlap	50

Best for:

Cushioning

Moisture Protection

Suitable for:

Sound Reduction

Underfloor Heating



Top



Bottom





# Medium Traffic



## Barrier & Barrier Plus Underlay

Lightweight PE foam **wood underlay for medium traffic** with vapour barrier.

Suitable for use with laminate and engineered wood flooring (floating floor installation).

### Protects against damp

**Barrier** has a clear printed vapour barrier on one side, which effectively and economically stops moisture rising from the subfloor to keep your floor dry.

**Barrier Plus** has a vapour barrier on both sides and a double overlap, so you're even better protected against rising moisture to keep your floor bone dry.

### Support against impact shock

Barrier and Barrier Plus give your floor covering the perfect level of support, guarding against excess wear and even high impact damage. It feels good under your feet, too!

### Light fantastic

While they're not lightweight in performance, **Barrier** and **Barrier Plus** certainly are easier and safer to lift and handle compared with many underlays - thanks to their ultra-lightweight PE foam making them a breeze to lift and move around... saving time and effort during installation.

The advanced moisture barrier gives this underlay even better resistance to fungi, mould and bacteria and dust-free installation means it is cleaner and easier to work with.

Made with 100% recyclable polyethylene foam.

Our Barrier Jointing Tape can be used with Barrier wood underlays for added joint seal protection, extra strength and stability, see page 104.



**QA** **Barrier**  
Underlay



Available in

Code	Size	Thickness	Pallet QTY
QAU-BAR-01	1m x 15m (15m <sup>2</sup> )	3mm	50

Best for:

Cushioning

Moisture Protection

Suitable for:

Sound Reduction

Underfloor Heating

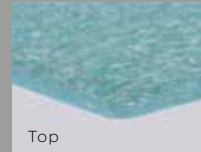

**QA** **Barrier Plus**  
Underlay



Available in

Code	Size	Thickness	Pallet QTY
QAU-BAR-02	1m x 15m (15m <sup>2</sup> )	3mm + Overlap	50

Best for:

Cushioning

Moisture Protection

Suitable for:

Sound Reduction

Underfloor Heating

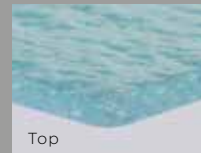



Dense PE foam featuring **ultimate damp protection**.

### **Ultimate protection against moisture**

Don't worry about moisture rising up from the subfloor - ProTech is laminated with a full 1000-gauge damp-proof membrane (300 above the industry standard), plus a joint sealing system to keep your room dry as a bone.

### **Shhh! Underlay at work**

Sound insulation... no need to worry about noise levels. ProTech has the added benefit of providing up to 22dB sound reduction.

### **Lightening the load**

The lightweight polyethylene material means ProTech's not only a breeze to lift and move around, but also quick and easy to cut and install - saving time and effort during installation.



Medium  
Traffic





# ProTech Underlay



Available in

Code	Size	Thickness	Pallet QTY
QAU-PRT-01	1m x 10m (10m <sup>2</sup> )	3mm + Overlap and s/a Strip	50

Best for:

Cushioning

Moisture Protection

Sound Reduction

Suitable for:

Underfloor Heating



Top



Bottom





# Medium Traffic



**FineFloor FibreBoard & FineFloor TechniBoard**  
Underlay

Lightweight panels to **eliminate uneven subfloors** and improve insulation.

Suitable for use with laminate and engineered wood flooring (floating floor installation).

FineFloor Fibreboard is made from natural wood fibre, offering eco-friendly and stable support for your floor. Not only is the material completely natural and 100% recyclable, Fibreboard is really easy to line up, fit and cut saving you time during installation.

FineFloor Techniboard is made from clever XPS material, providing a lightweight yet durable solution for uneven subfloors. The modern polystyrene material is easy to lift and move around, helping to get the job done quickly.

Being dust and fibre free means TechniBoard is cleaner to install and helps prevent allergy problems.

### Keep out the cold

With exceptional insulation properties, the FineFloor range is perfect for use on ultra-cold subfloors. So, in a basement for example, it'll make your room feel so much cosier and usable.

### Quietly does it

Both Fibreboard and Techniboard have high impact sound reduction, deadening any loud noise to make the whole room quieter and more peaceful.





## FineFloor FibreBoard Underlay

Available in

Code	Size	Thickness	Pallet QTY
QAU-FFF-01	22 panels 590mm x 850mm x (11.03m <sup>2</sup> )/pack	4mm	24
QAU-FFF-02	20 panels 590mm x 850mm (10.03m <sup>2</sup> )/pack	5mm	22
QAU-FFF-03	14 panels 590mm x 850mm (7.02m <sup>2</sup> )/pack	5mm	32
QAU-FFF-04	17 panels 590mm x 850mm (8.59m <sup>2</sup> )/pack	7mm	18



Best for:

Level Floors

Heat Insulation

Suitable for:

Sound Reduction



Top

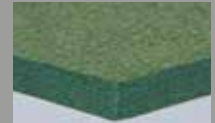

Bottom



## FineFloor TechniBoard Underlay

Available in

Code	Size	Thickness	Pallet QTY
QAU-FFT-01	10 panels 1200mm x 500mm (6m <sup>2</sup> )/pack	5mm	72
QAU-FFT-02	21 panels 590mm x 790mm (9.79m <sup>2</sup> )/pack	5mm	46

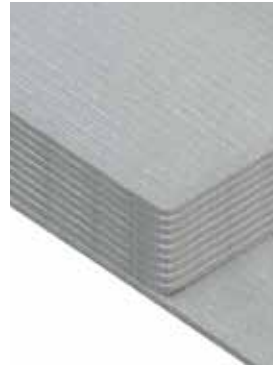

Best for:

Level Floors

Heat Insulation

Suitable for:

Sound Reduction



Top



Bottom





# Medium Traffic



## QuickTherm & QuickTherm Vapour Underlay

Perforated PE foam underlay specially designed for **underfloor heating**.

Suitable for use with laminate and engineered wood flooring (floating floor installation).

QuickTherm is a red PE foam underlay with innovative perforations which allow optimum transfer of heat from an underfloor heating system to the room.

QuickTherm Vapour is orange in colour and has the additional benefit of a built-in vapour barrier with overlap, to stop moisture rising up from the subfloor.

### The underfloor heating underlay

Along with the unique perforated design, QuickTherm and QuickTherm Vapour have extremely low tog ratings ensuring your underfloor heating system can work more efficiently which helps with your energy consumption (QuickTherm 0.35 Tog / QuickTherm Vapour 0.303 Tog).

### Lifelong supporter

The very dense closed-cell polyethylene material can take the weight of heavy loads long-term, supporting and protecting your floor to keep it in good shape for a longer life.

### Easy installation

QuickTherm and QuickTherm Vapour are strong on performance but light in weight making it easy and convenient to transport during installation; and being 100% recyclable and dust-free means there is less clean up to do afterwards!

Go to [qaflooringsolutions.com](http://qaflooringsolutions.com) for installation guidelines.





## QuickTherm Underlay



Available in

Code	Size	Thickness	Pallet QTY
QAU-QTH-01	1m x 10m (10m <sup>2</sup> )	1.8mm	120

Best for:

Hard Wearing

Underfloor Heating

Suitable for:

Sound Reduction



Top



Bottom



## QuickTherm Vapour Underlay



Available in

Code	Size	Thickness	Pallet QTY
QAU-QTH-02	1m x 10m (10m <sup>2</sup> )	2mm + Overlap	120

Best for:

Moisture Protection

Underfloor Heating

Suitable for:

Sound Reduction



Top



Bottom





# Heavy Traffic



## TimberTech Elite & Elite Plus Underlay

Wood underlays that deliver a new level of **noise reduction** and comfort.

Suitable for use with laminate, engineered and solid wood flooring (floating floor installation).

### **Ideal for underfloor heating**

With a very low tog value of 0.1, TimberTech Elite and Elite Plus are the perfect choice if you have underfloor heating, letting it heat the room more efficiently.

### **Shhh! Underlay at work**

TimberTech Elite Plus reduces walking noise by up to 32% and impact sound by up to 21dB, cutting down noise level and making the room a more comfortable place to be.

### **Provides strength & stability**

The high density and compressive strength fully support the floor and prevent movement, keeping it in good shape for a longer life.

### **Protects against moisture**

A silver vapour barrier gives superior protection against moisture rising from the sub-floor, keeping your floor dry.





## TimberTech Elite

Underlay



Available in

Code	Size	Thickness	Pallet QTY
QAU-TTE-01	1m x 10m (10m <sup>2</sup> )	2mm	56

Best for:

Hard Wearing

Compression Recovery

Underfloor Heating

Suitable for:

Moisture Protection

Sound Reduction

Commercial Use

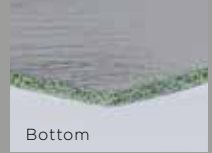
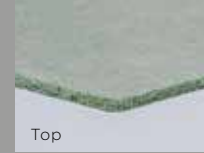

## TimberTech Elite Plus

Underlay



Available in

Code	Size	Thickness	Pallet QTY
QAU-TTE-02	1m x 10m (10m <sup>2</sup> )	3mm	38

Best for:

Hard Wearing

Compression Recovery

Underfloor Heating

Suitable for:

Moisture Protection

Sound Reduction

Commercial Use





# Heavy Traffic



## TimberTech Neo & TimberTech Neo Acoustic Underlay

Heavyweight natural crumb rubber underlay with **outstanding noise reduction.**

### Shhh! Underlay at work

TimberTech Neo is a 3mm thick, rubber crumb underlay providing an impressive 23dB sound reduction.

TimberTech Neo Acoustic is a 5mm thick rubber crumb underlay making it a winner for heavy weight jobs. In addition, this superb underlay has a felt backing which provides stability when cutting and installing and an even more impressive 26dB sound reduction.

### Dry as a bone

The silver vapour barrier on TimberTech Neo and the gold vapour barrier on TimberTech Neo Acoustic prevent moisture rising from the sub-floor – protecting your floor covering against damp.

### Old tyre, new life

TimberTech is made with rubber from recycled tyres, which means old tyres don't go into landfill – so it's better for the planet.

Use QA Vapour Tape on joints for added moisture protection. See page 104.







## TimberTech Neo Underlay



Available in

Code	Size	Thickness	Pallet QTY
QAU-TNE-01	1m x 10m (10m <sup>2</sup> )	3mm	40

Best for:

Hard Wearing

Sound Reduction

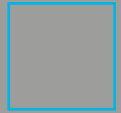

Suitable for:

Moisture Protection

Underfloor Heating



Top



Bottom



## TimberTech Neo Acoustic Underlay



Available in

Code	Size	Thickness	Pallet QTY
QAU-TNA-01	1m x 8m (8m <sup>2</sup> )	5mm	20

Best for:

Hard Wearing

Sound Reduction

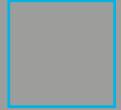

Suitable for:

Level Floors

Moisture Protection

Underfloor Heating



Top



Bottom





## TimberTech2 Silver & TimberTech2 Silver Plus Underlay

High density natural rubber, with **fleece backing and vapour barrier.**

### Flooring stays put

The high density, fleece-backed natural rubber is extremely stable and prevents movement in your flooring, greatly reducing wear and tear!

### Shhh! Underlay at work

TimberTech2 Silver is excellent at absorbing both impact and in-room noise, to really cut down noise levels in any room.

### Protects against damp

Don't worry about moisture rising up from the sub-floor - the silver vapour barrier film protects your floor covering and keeps your room dry as a bone.

With exceptional resistance to compression, TimberTech2 Silver provides solid and stable support even under the heaviest weight.

The high tensile strength of TimberTech2 Silver Plus gives it superior performance in any installation.

Being dust free means it's cleaner and easier to install, with less clearing up afterwards.

# Heavy Traffic



## TimberTech2 Silver Underlay



Available in

Code	Size	Thickness	Pallet QTY
QAU-TTS-01	1m x 10m (10m <sup>2</sup> )	2mm	50

Best for:

Hard Wearing

Compression Recovery

Underfloor Heating

Suitable for:

Moisture Protection

Sound Reduction



Top



Bottom



## TimberTech2 Silver Plus Underlay



Available in

Code	Size	Thickness	Pallet QTY
QAU-TTS-02	1m x 10m (10m <sup>2</sup> )	3mm	40

Best for:

Hard Wearing

Compression Recovery

Underfloor Heating

Suitable for:

Moisture Protection

Sound Reduction



Top



Bottom





# Heavy Traffic



## TimberTech2 Gold Underlay

Premium ultra-thick natural rubber underlay with **vapour barrier**.

### Stability you can rely on

TimberTech2 Gold's heavy mass stability is exceptional, preventing movement in your flooring to keep it looking good longer.

### Quiet please...

With its ultra-thick laminated material, TimberTech2 Gold has an outstanding acoustic performance of 23dB to make any room more comfortable.

### Protects against damp

A gold vapour barrier gives superior protection against moisture rising from the sub-floor - so your room stays dry.



## TimberTech2 Acoustic Plus Underlay

Heavyweight natural rubber underlay with **outstanding noise reduction**

### The sound of silence...

TimberTech2 Acoustic Plus has an exceptional impact sound insulation level of 27dB - really bringing down noise levels in the room and making it a better place to be.

### Protects against moisture

The gold vapour barrier stops your floor covering being damaged by moisture rising up from the sub-floor.

### Heavyweight champ

The heavy mass stability of TimberTech2 Acoustic Plus means your floor's always fully supported, reducing the wear and tear to it, whatever a pounding it takes!

The high tensile strength of TimberTech2 Acoustic Plus makes it suitable for any installation - including commercial use.



## TimberTech2 Gold Underlay



Available in

Code	Size	Thickness	Pallet QTY
QAU-TTG-01	1m x 10m (10m <sup>2</sup> )	3.3mm	30

Best for:

Hard Wearing

Sound Reduction

Commercial Use

Suitable for:

Moisture Protection

Underfloor Heating



Top



Bottom



## TimberTech2 Acoustic Plus Underlay



Available in

Code	Size	Thickness	Pallet QTY
QAU-TTA-02	1m x 8m (8m <sup>2</sup> )	5mm	20

Best for:

Hard Wearing

Sound Reduction

Commercial Use

Suitable for:

Level Floors

Moisture Protection

Underfloor Heating



Top



Bottom



# Wooderlays



## Wood Underlays Light Traffic

Product	Density	Impact Sound Reduction	Thermal Resistance	Compressive Strength	Reaction to fire
	kg/m <sup>3</sup>	dB	Tog Value	kPa	
UniBase Bronze	20 ± 10%	-19 (2mm) -20 (3mm)	0.44 (2mm) 0.67 (3mm)		
AWC15	20 ± 10%	-20	0.67		
UniBase Silver	20 ± 10%	-19 (2mm)	0.44		
UniBase Gold	20 ± 10%	-20	0.67		
Silver Lux	20 ± 10%	-20	0.67		

## Wood Underlays Medium Traffic

Product	Density	Impact Sound Reduction	Thermal Resistance	Compressive Strength	Reaction to fire
	kg/m <sup>3</sup>	dB	Tog Value	kPa	
Barrier	20 ± 10%	-20	0.67		
Barrier Plus	20 ± 10%	-20	0.67		
ProTech	25 ± 10%	22	0.67		
FibreBoard 4mm	260 ± 10%	18	0.8	>150	
FibreBoard 5mm	260 ± 10%	18	1	>150	
FibreBoard 7mm	260 ± 10%	18	1.4	>150	
TechniBoard	40 ± 10%	-19	2.15		
QuickTherm	100 ± 10%	-19	0.35		
QuickTherm Vapour	60 ± 10%	-19	0.303		

## Wood Underlays Heavy Traffic

Product	Density	Impact Sound Reduction	Thermal Resistance	Compressive Strength	Reaction to fire
	kg/m <sup>3</sup>	dB	Tog Value	kPa	
TimberTech Elite	850 ± 10%	20 ± 2	0.1	up to 240	Bfl-s1
TimberTech Elite Plus	850 ± 10%	21 ± 2	0.1	up to 120	Bfl-s1
TimberTech Neo	400 ± 10%	22	0.72		Pass (Low radius of effect)
TimberTech Neo Acoustic	400 ± 10%	26	0.73		Pass (Low radius of effect)
TimberTech2 Silver	950 ± 10%	-20	0.3		Pass (Low radius of effect)
TimberTech2 Silver Plus	950 ± 10%	-21	0.37		Pass (Low radius of effect)
TimberTech2 Gold	950 ± 10%	-23	0.53		Pass (Low radius of effect)
TimberTech2 Acoustic Plus	950 ± 10%	-27	0.66		Pass (Low radius of effect)

All technical data provided in this publication is subject to variation. It is partly based on data from our suppliers and reflects the current level of industry expertise. It is not legally binding. Compliance with legal requirements remains the customer's own responsibility.



The logo consists of the letters 'QA' in a bold, white, sans-serif font, set against a solid black square background.

**Simply Better**

# Carpet Underlays

It's easy to think all carpet underlays are the same. After all, they spend most of their life hidden away. But you'd be surprised how much difference choosing the right underlay can make to any room. Mainly it is about comfort, but it can also be about keeping flooring looking good for longer.



## Traffilay Group

### Light Traffic

	Cushioning	Level Floors	Hard Wearing	Moisture Protection	Compression Recovery	Heat Insulation	Sound Reduction	Underfloor Heating	Commercial Use	Page No
FloorSure Silver	■				■	■	■			42
FloorSure Gold	■				■	■	■			42
FloorSure Platinum	■				■	■	■			42

### Medium Traffic

SpringBack Silver	■				■	■	■			44
SpringBack Gold	■				■	■	■			44

### Heavy Traffic

Pure Super High Density 9mm	■		■		■	■	■			48
Pure Super High Density 11mm	■		■		■	■	■			48
Pure Ultra High Density 9mm	■		■		■	■	■			50
Pure Ultra High Density 11mm	■		■		■	■	■			50
PowerWalk Silver	■		■		■	■	■			52
PowerWalk Gold	■		■		■	■	■			52
CombiFelt Acoustic			■				■		■	54
HeatWave	■		■		■		■	■		56
ExtraStep			■		■		■	■	■	58
QBond 65			■		■		■	■	■	60



# Carpet Underlays

Light  
Traffic



**FloorSure Silver, Gold & Platinum**  
Underlay

Resilient PU foam with a **truly luxurious feel.**

### **Feels great to feet**

FloorSure is made from a polyurethane foam that's light in weight but gives your feet a real treat – warm and comfortable, coupled with a softness that feels simply gorgeous!

### **Light fantastic**

FloorSure is certainly much easier and safer to lift and handle compared with sponge rubber and felt underlays – thanks to its lightweight PU foam.

FloorSure also offers very good thermal insulation, to help your whole room feel warmer and more comfortable.

It's not only light and easy to manoeuvre, but also quick and easy to cut and install – saving time on installation.

Made with 100% recyclable polyurethane foam.





## FloorSure Silver Underlay



Available in

Code	Size	Thickness	Pallet QTY
QAU-FSS-01	1.37m x 11m (15.07m <sup>2</sup> )	8mm	28

Best for:

Cushioning

Compression Recovery

Suitable for:

Heat Insulation

Sound Reduction



Top



Bottom



## FloorSure Gold Underlay



Available in

Code	Size	Thickness	Pallet QTY
QAU-FSG-01	1.37m x 11m (15.07m <sup>2</sup> )	10mm	21

Best for:

Cushioning

Compression Recovery

Sound Reduction

Suitable for:

Heat Insulation



Top



Bottom



## FloorSure Platinum Underlay



Available in

Code	Size	Thickness	Pallet QTY
QAU-FSP-01	1.37m x 11m (15.07m <sup>2</sup> )	12mm	18

Best for:

Cushioning

Compression Recovery

Sound Reduction

Suitable for:

Heat Insulation



Top



Bottom



# Carpet Underlays

## Medium Traffic



**SpringBack Silver & Gold**  
Underlay

A premium PU foam underlay  
**with excellent bounce back ability.**

### **Pure underfoot luxury**

SpringBack top-grade polyurethane foam has an unbelievable softness to give unbeatable underfoot comfort.

### **SpringBack by name...and nature**

It's all in the name...SpringBack really performs under pressure, retaining its ability to spring back much better than a typical sponge rubber product. Your carpet will look good for so much longer!

### **Designed for durability**

SpringBack is extremely hardwearing and won't dry out, crumble or react to everyday household cleaners. In fact, it's guaranteed for the lifetime of the carpet!

Made with 100% recyclable polyurethane foam.





# SpringBack Silver Underlay



Available in

Code	Size	Thickness	Pallet QTY
QAU-SBS-01	1.37 x 11m (15.07m <sup>2</sup> )	8mm	24

Best for:

Cushioning

Compression Recovery

Suitable for:

Heat Insulation

Sound Reduction



Top



Bottom



# SpringBack Gold Underlay



Available in

Code	Size	Thickness	Pallet QTY
QAU-SBG-01	1.37 x 11m (15.07m <sup>2</sup> )	10mm	21

Best for:

Cushioning

Compression Recovery

Sound Reduction

Suitable for:

Heat Insulation



Top



Bottom





# Luxuriously Pure PU Underlay

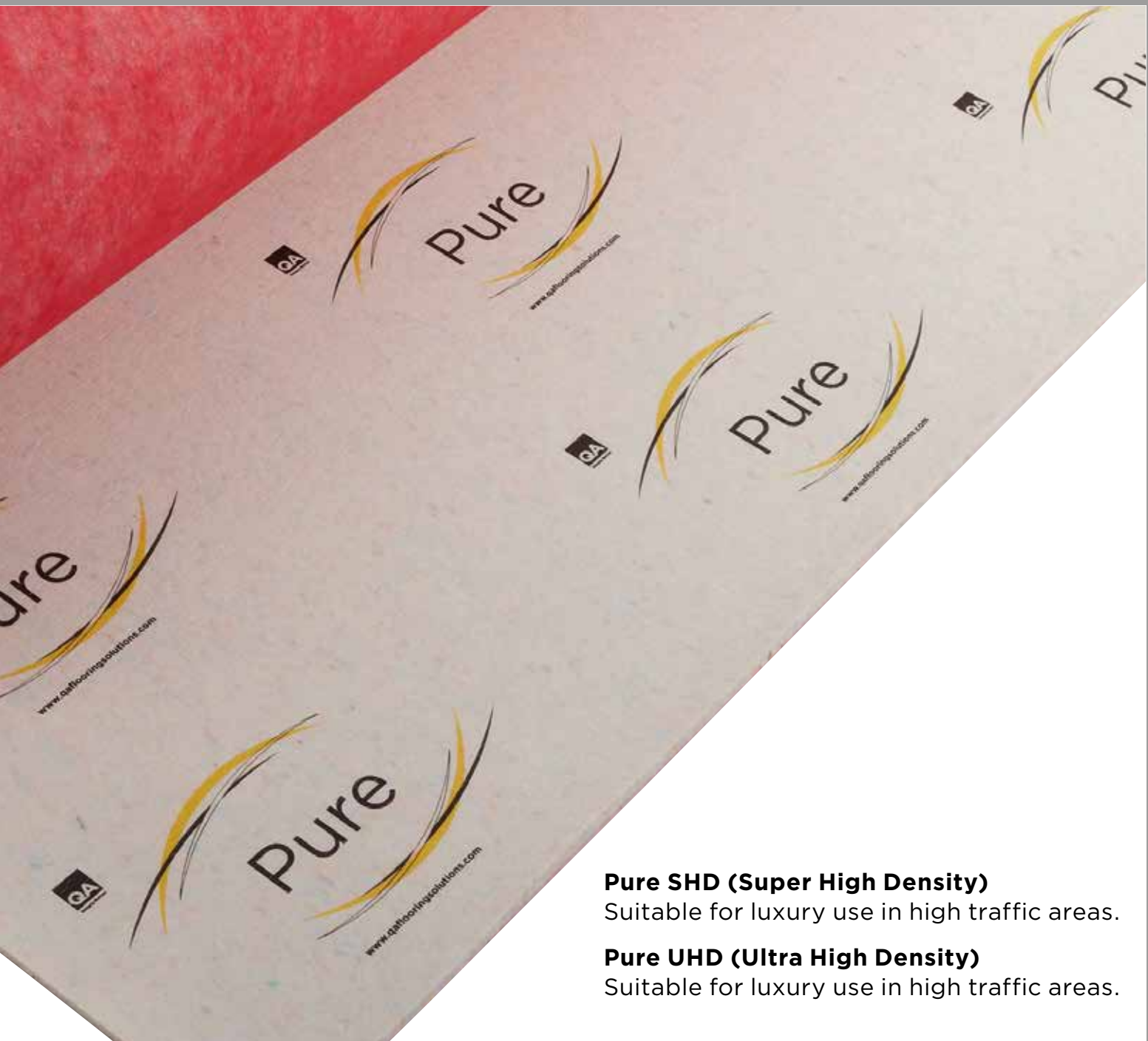

**Pure SHD (Super High Density)**

Suitable for luxury use in high traffic areas.

**Pure UHD (Ultra High Density)**

Suitable for luxury use in high traffic areas.



# Carpet Underlays

## Pure



Introducing a **luxurious collection of PU carpet underlay**, which is as indulgent as it is robust.

**Only the purest, highest-grade foam is used in the production of the Pure range, setting a new industry standard in comfort.**

The material used is subject to a stringent sorting process which removes imperfections and lower grade dark coloured foam, resulting in an impeccably clean PU material. This gives Pure the most sumptuous feel under the carpet, unsurpassed by other luxury underlays on the market.

- Two different density options available - Super High Density (SHD) and Ultra High Density (UHD)
- Pure SHD and UHD available in both 9mm and 11mm
- Non-woven backing and printed top layer for improved stability
- Pure branded premium packaging

Made with 100% recyclable polyurethane foam.







## Pure SHD 9mm Underlay

Suitable for luxury domestic use in heavy traffic areas.



Available in

Code	Size	Thickness	Pallet QTY
QAU-PUR-03	1.37m x 11m (15.07m <sup>2</sup> )	9mm	21



Best for:

Compression  
Recovery

Sound  
Reduction



Suitable for:

Cushioning

Hard  
Wearing

Heat  
Insulation



Top



Bottom



## Pure SHD 11mm Underlay

Suitable for luxury domestic use in heavy traffic areas.



Available in

Code	Size	Thickness	Pallet QTY
QAU-PUR-04	1.37m x 11m (15.07m <sup>2</sup> )	11mm	18



Best for:

Compression  
Recovery

Heat  
Insulation

Sound  
Reduction

Suitable for:

Cushioning

Hard  
Wearing



Top



Bottom

# Heavy Traffic

MASSIVE SAVINGS ON HIGH VOLUME ORDERS, CALL 0151 495 3434 FOR PRICES



49



## Pure UHD 9mm Underlay

Suitable for luxury domestic use in heavy traffic areas.



Available in

Code	Size	Thickness	Pallet QTY
QAU-PUR-05	1.37m x 11m (15.07m <sup>2</sup> )	9mm	21



Best for:

Hard Wearing

Compression Recovery

Sound Reduction

Suitable for:

Cushioning

Heat Insulation



Top



Bottom



## Pure UHD 11mm Underlay

Suitable for luxury domestic use in heavy traffic areas.



Available in

Code	Size	Thickness	Pallet QTY
QAU-PUR-06	1.37m x 11m (15.07m <sup>2</sup> )	11mm	18



Best for:

Hard Wearing

Compression Recovery

Sound Reduction

Suitable for:

Cushioning

Heat Insulation



Top

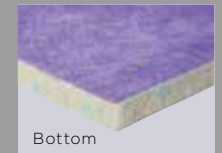

Bottom

# Heavy Traffic



MASSIVE SAVINGS ON HIGH VOLUME ORDERS, CALL 0151 495 3434 FOR PRICES



# Carpet Underlays

## Heavy Traffic



## PowerWalk Silver & Gold Underlay

High Density PU foam underlay perfect **for heavy duty domestic use.**

### High density and hardwearing

The polyurethane foam in PowerWalk is extra high density (130kg/m<sup>3</sup>) so it's extremely hardwearing, keeping your carpet looking good for longer.

### Performance under pressure

Under pressure, this is an underlay that really performs - with excellent compression recovery - to help your carpet keep that 'just-fitted' look.

### Keeps flooring in its place

PowerWalk Silver has excellent stability to stop movement in your carpet, greatly reducing wear and tear.

### Excellent thermal insulation

PowerWalk Silver has a 2.3 tog rating with PowerWalk Gold delivering 2.92 tog performance; which means your whole room feels warmer and more comfortable.

### Sound reduction

The sheer density of PowerWalk helps give it first-rate impact and sound insulation (Silver 38dB / Gold 44dB), making your room quieter.

Made with 100% recyclable polyurethane foam.





## PowerWalk Silver Underlay



Available in

Code	Size	Thickness	Pallet QTY
QAU-PWS-01	1.37m x 11m (15.07m <sup>2</sup> )	9mm	20

Best for:

Hard Wearing

Compression Recovery



Suitable for:

Cushioning

Heat Insulation

Sound Reduction



Top



Bottom



## PowerWalk Gold Underlay



Available in

Code	Size	Thickness	Pallet QTY
QAU-PWG-01	1.37m x 11m (15.07m <sup>2</sup> )	11mm	20

Best for:

Hard Wearing

Compression Recovery

Sound Reduction

Suitable for:

Cushioning

Heat Insulation



Top



Bottom



# Carpet Underlays

## Heavy Traffic



**CombiFelt Acoustic**  
Underlay

Extra-tough felt and rubber combination, perfect **for prestige carpets.**

### **A touch more luxurious**

Giving a firm but truly plush feel under your feet, this is an ideal choice for luxury settings and is widely used under Axminster and quality twist carpets.

### **Built to last**

This underlay is designed for fantastic durability. It won't crumble over time and takes even the heaviest use in its stride - it exceeds BS5808 (Heavy Contract Use)!

### **Shhh! Underlay at work**

CombiFelt Acoustic has unbelievable impact sound insulation... so not only does it make your carpet feel softer and more luxurious but you'll notice a real difference in noise levels.





# CombiFelt Acoustic Underlay



Available in

Code	Size	Thickness	Pallet QTY
QAU-CFA-01	1.37m x 7.3m (10m <sup>2</sup> )	10mm	15

Best for:

Hard Wearing

Commercial Use

Suitable for:

Sound Reduction



Top



Bottom



# Carpet Underlays

## Heavy Traffic



**HeatWave**  
Underlay

A super soft flame retardant PU foam underlay which is specially **designed for use with under floor heating.**

### **Fire safety comes first**

HeatWave is designed to be safer if a fire breaks out in the home, thanks to its flame retardant properties...so there's no need to worry about hidden dangers under your floor if the worst should happen.

### **That soft feeling...**

HeatWave is made from very pure polyurethane foam, so is incredibly soft and gives unbeatable underfoot comfort...sitting on your carpet will feel like sitting on your sofa!

### **Heatwave under the floor**

HeatWave has a tog value of only 1.2, which allows underfloor heating to work away at keeping the room nice and warm.

Made with 100% recyclable polyurethane foam.







# HeatWave Underlay



Available in

Code	Size	Thickness	Pallet QTY
QAU-HWA-01	1.37m x 11m (15.07m <sup>2</sup> )	8mm	32

Best for:

Cushioning

Compression Recovery

Underfloor Heating

Suitable for:

Hard Wearing

Sound Reduction

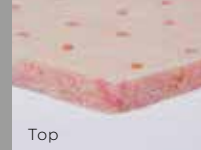

# Carpet Underlays

## Heavy Traffic



**ExtraStep**  
Underlay

Extra high-density (180kg) 6mm PU underlay with 33dB sound reduction; **suitable for underfloor heating.**

Suitable for heavy domestic, commercial and marine jobs and double stick installation - a common method used for fast installation that helps reduce rucking in high traffic areas.



# ExtraStep Underlay



Available in

Code	Size	Thickness	Pallet QTY
QAU-WFF-01	1.37m x 11m (15.07m <sup>2</sup> )	6mm	34

Best for:

Hard  
Wearing

Compression  
Recovery

Commercial  
Use

Suitable for:

Sound  
Reduction

Underfloor  
Heating



Top



Bottom

# Carpet Underlays

## Heavy Traffic



**QBond 65**  
Underlay

Heavy duty crumb rubber underlay  
**for double stick contract carpet installations.**

### **Commercial quality**

Ideal for commercial double stick installations where high performance is required, such as hotels, schools, offices and any large contract carpet area.

### **Environmentally friendly**

Manufactured from a high content of recycled vehicle tyres.

### **Excellent compression recovery**

Offers excellent recovery from indentations from loads such as heavy furniture.

### **Sound reduction**

Impact sound reduction results ranging from 27dB to 33dB. Offering excellent acoustic properties.

Go to [qaflooringsolutions.com](http://qaflooringsolutions.com) for installation guidelines.





# QBond 65

## Underlay



Available in

Code	Size	Thickness	Pallet QTY
QAU-QBD-01	1.37m x 11m (15.07m <sup>2</sup> )	6.5mm	16

Best for:

Hard Wearing

Underfloor Heating

Commercial Use

Suitable for:

Compression Recovery

Sound Reduction



Top



Bottom





# COMFORT UNDERFOOT STARTS WITH QA - STEP RIGHT THIS WAY!

QA PU underlays are made from high-density foam and have a strong non-woven fleece layer on both sides. They are tested and recommended for luxury use.

\*Premium non-woven fleece gives a soft feel and makes the underlay very stable (preventing stretching and rucking under the carpet).

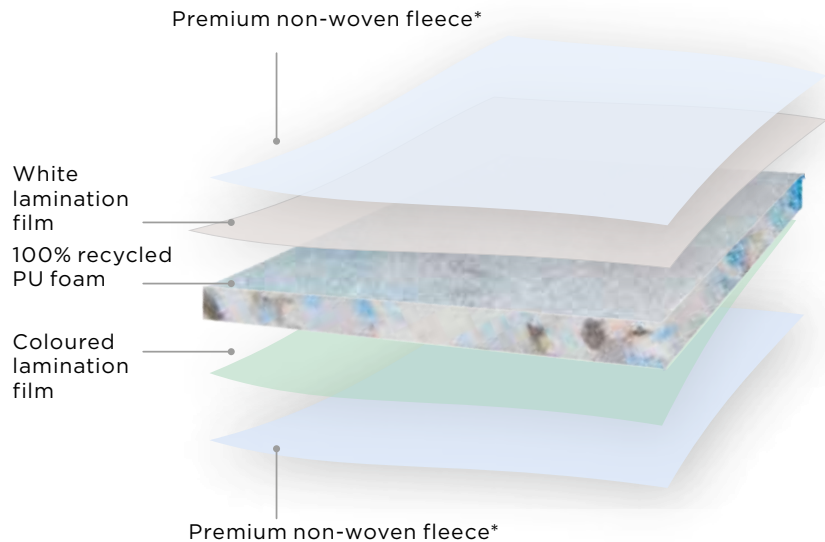

## Carpet Underlays Light Traffic

Product	Density	Thickness	Impact Sound Reduction	Thermal Resistance	Flammability
	kg/m <sup>3</sup>	mm	dB	Tog Value	
<b>FloorSure Silver</b>	75 ± 5%	8 ± 5%	32	2.18	Pass - High Radius of effect
<b>FloorSure Gold</b>	75 ± 5%	10 ± 5%	40	2.6	Pass - High Radius of effect
<b>FloorSure Platinum</b>	75 ± 5%	12 ± 5%	44	2.95	Pass - High Radius of effect

## Carpet Underlays Medium Traffic

Product	Density	Thickness	Impact Sound Reduction	Thermal Resistance	Flammability
	kg/m <sup>3</sup>	mm	dB	Tog Value	
<b>SpringBack Silver</b>	85 ± 5%	8 ± 5%	34	2.3	Pass - Medium Radius of effect
<b>SpringBack Gold</b>	85 ± 5%	10 ± 5%	40	2.75	Pass - Medium Radius of effect

## Carpet Underlays Heavy Traffic

Product	Density	Thickness	Impact Sound Reduction	Thermal Resistance	Flammability
	kg/m <sup>3</sup>	mm	dB	Tog Value	
<b>Pure Super High Density</b>	100 ± 5%	9 ± 5% (9mm)	44	2.43 (9mm)	Pass - Medium Radius of effect
		11 ± 5% (11mm)	46	3.04 (11mm)	
<b>Pure Ultra High Density</b>	145 ± 5%	9 ± 5% (9mm)	44	2.44 (9mm)	Pass - Medium Radius of effect
		11 ± 5% (11mm)	46	2.81 (11mm)	
<b>PowerWalk Silver</b>	130 ± 5%	9 ± 5%	38	2.3	Pass - Low Radius of effect
<b>PowerWalk Gold</b>	130 ± 5%	11 ± 5%	44	2.92	Pass - Low Radius of effect
<b>CombiFelt Acoustic</b>		10 ± 5%	34		Pass - Low Radius of effect
<b>HeatWave</b>	110 ± 5%	8 ± 5%	36	1.2	Pass - Low Radius of effect
<b>ExtraStep</b>	180 ± 5%	6 ± 5%	33	1.77	Pass - Low Radius of effect
<b>QBond 65</b>	400 ± 5%	6.5 ± 5%	30	1.1	Pass - Low Radius of effect

All technical data provided in this publication is subject to variation. It is partly based on data from our suppliers and reflects the current level of industry expertise. It is not legally binding. Compliance with legal requirements remains the customer's own responsibility.





**Simply Better**

# Acoustic Solutions

A range of industry leading acoustic materials to help meet or surpass Building Regulations for England, Wales, Scotland and Ireland. We have the expertise to provide you with the correct solution to combat airborne and impact noise.



Traffilay  
Group

# Heavy Traffic

	Cushioning	Level Floors	Hard Wearing	Moisture Protection	Compression Recovery	Heat Insulation	Sound Reduction	Underfloor Heating	Commercial Use	Page No
Acoustic Systems										
SoundBarrier			■				■	■		66
Regupol Sonus 3912		■	■				■		■	68
Regupol Sonus 4515 Multi 3mm			■				■	■	■	68
Regupol Sonus 4515 Multi 4.5mm			■				■		■	68
Regupol Sonus 4515 Eco 3mm			■				■	■	■	68
Regupol Sonus 4515 Eco 4.5mm			■				■		■	68
Quiet Roll Standard 2mm			■				■	■	■	70
Quiet Roll Standard 5mm		■	■				■	■	■	70
Quiet Roll Universal			■				■	■	■	70
E-Board Timber		■				■	■		■	72
E-Board Concrete		■				■	■		■	72
E-Board Pro		■				■	■		■	72



# Acoustic Solutions

## Heavy Traffic



**SoundBarrier**  
Underlay

High performance acoustic underlay for both **glue down and click LVT installations.**

### **Quietly does it**

SoundBarrier provides an exceptional 24dB of impact sound reduction - higher than any other LVT underlay available. It also reduces walking noise by 31%, making the room a whole lot quieter.

### **Built to last**

Made from a high-density polypropylene foam, SoundBarrier will easily last the lifetime of the floor, even under the heaviest foot traffic. It creates a stable base which supports the floor for life.

### **Protects against damp**

The unique moisture-guard properties of SoundBarrier stop moisture getting through from the sub-floor, keeping the floor dry.

### **Light fantastic**

Lightweight material makes it easier to manoeuvre unlike other rubber products.



# SoundBarrier Underlay



Available in

Code	Size	Thickness	Pallet QTY
QAU-SBR-02	0.89m x 16.85m (15m <sup>2</sup> )	1mm	105

Best for:

Hard Wearing

Sound Reduction

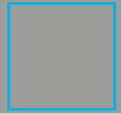

Suitable for:

Underfloor Heating



Top



Bottom



# Acoustic Solutions

## Heavy Traffic



**Regupol Sonus**  
Underlay

Acoustic system which helps **comply with Part E of Building Regulations.**

**Regupol® Sonus 3912** is a tough, resilient acoustic underlay manufactured from PUR Foam and is ideally suited to refurbishment and timber-based constructions to comply with Part E. It can also be used for new build.

**Regupol® Sonus 4515 Multi & Eco** are multi-purpose acoustic underlay systems which help comply with Part E of Building Regulations for impact sound reduction. They can be used over most types of sub floor and with all types of floor finish.

### **Performance under pressure**

Regupol® Sonus offers long term performance without collapse or “bottoming” out under high point loads and is resistant to ageing and deformation. With high quality and exact material thickness guaranteed, it reduces construction heights.

### **Comfort under foot**

Suitable for use with under floor heating and is also very comfortable under foot.

### **Fit it fast!**

Quick and easy to install. Simply bond to the subfloor beneath the final floor finish.

Manufactured using recycled materials and 100% recyclable.

Consultation with our Technical Support Team is recommended prior to specification.





## Regupol Sonus 3912 Underlay



Available in

Code	Size	Thickness	Pallet QTY
RP3912	1m x 15m (15m <sup>2</sup> )	6mm	15

Best for:

Hard Wearing

Sound Reduction

Commercial Use

Suitable for:

Level Floors



Top



Bottom



## Regupol Sonus Multi Underlay



\* Only 3mm suitable for underfloor heating.

Available in

Code	Size	Thickness	Pallet QTY
RP4515M3	1m x 20m (20m <sup>2</sup> )	3mm	15
RP4515M45	1m x 18m (18m <sup>2</sup> )	4.5mm	15

Best for:

Hard Wearing

Sound Reduction

Commercial Use

Suitable for:

Underfloor Heating



Top



Bottom



## Regupol Sonus Eco Underlay



\* Only 3mm suitable for underfloor heating.

Available in

Code	Size	Thickness	Pallet QTY
RP4515E3	1.15m x 20m (23m <sup>2</sup> )	3mm	20
RP4515E45	1.15m x 12m (13.8m <sup>2</sup> )	4.5mm	20

Best for:

Hard Wearing

Sound Reduction

Commercial Use

Suitable for:

Underfloor Heating



Top



Bottom



# Acoustic Solutions

## Heavy Traffic



QA Quiet Roll is a range of cork products which help comply with Part E of Building Regulations for impact sound reduction. There are products available to use with all types of floor finish. (See also SoundBarrier).

### Lightweight performance

Cork cells are filled with a mixture of gasses which reduce product weight, the composition of Cork is approximately 40% bark and 60% gas which helps keep the product lightweight.

### Benefits of cork

- Anti-Static
- Anti-Allergic
- Bug Resistant - Cork contains suberin which is a natural insect repellent
- Air Quality - Naturally antimicrobial and water resistant
- Fire - if cork is burnt, no toxic fumes are emitted
- Thermal Insulator - thin underlays are suitable for underfloor heating
- Carbon Negative - any waste is recycled back into the production line
- Sustainability - Portuguese Cork Oak Trees retain approximately 14 million tonnes of CO<sub>2</sub> yearly, no trees are cut or damaged when harvesting



Quiet Roll applied under a timber floor.





## Quiet Roll Standard Underlay

Made sustainably from recycled cork and EVA, providing a high level of insulation against impact noise.

\* Only 2mm suitable for underfloor heating.

\*\* Only 5mm suitable to level floors.

Available in

Code	Size	Thickness	Pallet QTY
QAU-CWO-01	1m x 10m (10m <sup>2</sup> )	2mm	35
QAU-CWO-02	1m x 10m (10m <sup>2</sup> )	5mm	12



Best for:

Hard Wearing

Sound Reduction

Commercial Use

Suitable for:

Underfloor Heating



Top



Bottom



## Quiet Roll Universal Underlay

A high density underlay made from 100% cork, suitable for fully glued installations of dryback LVT. Passes the Castor Chair Test when installed under LVT, making it suitable for areas of heavy foot and wheeled traffic.

Available in

Code	Size	Thickness	Pallet QTY
QAU-GRU-01	1m x 10m (10m <sup>2</sup> )	2mm	70



Best for:

Hard Wearing

Sound Reduction

Commercial Use

Suitable for:

Underfloor Heating



Top



Bottom

## Carbon Neutral & Environmentally Friendly

Cork underlay is produced from 100% pure natural cork material, assuring that any waste is inserted back into the production process. This contributes to a lower carbon footprint, 20x lower than a standard synthetic foam underlay. Therefore reducing global warming and improving the general sustainability of our planet. In a globally conscious world, fully aware of the importance of protecting our environment, cork is the most sensible and ecological choice.



# Acoustic Solutions

## Heavy Traffic



## E-Board Timber, E-Board Concrete & E-Board Pro Underlay

High performance underlay system for timber and concrete subfloors with **brilliant acoustic performance.**

**E-Board Timber** is a high-mass yet resilient high-performance acoustic underlay, designed to help reduce both impact and airborne noise that helps meet or surpass Building Regulations Part E Resistance to the Transmission of Sound, primarily for timber sub-floors.

**E-Board Concrete** is ideal for new, retrofit or renovation projects in offices, homes and hotels. E-Board Concrete helps meet or surpass Building Regulations Part E Resistance to the Transmission of Sound, primarily for concrete sub-floors.

**E-Board Pro** - High Mass acoustic resilient layer that has been specifically designed to reduce impact and airborne noise primarily on timber floors.

### Quiet please...

E-Board with a layer of Class O Acoustic Foam under or sandwiched between an acoustic barrier means excellent impact (53-57dB) and airborne sound (47-54dB) insulation - ideal for new, retrofit or renovation projects in offices, homes and hotels.

### Fire safe and sound

Meeting BS476: parts 6 & 7 - the highest level for Class O - the Acoustic Foam is a fully tested for fire resistance - and peace of mind.

### Commercial or residential - meet the regs

Whether it's used in commercial or residential installations, you can rely on E-Board to fully comply with Doc E of the Building Regulations.

Ideal under any floor finish - carpet can be fitted directly onto it, but for solid wood, laminate, ceramic, or vinyl we recommend adding 6mm ply or MDF to reduce flex.

With any type of uneven subfloor, the E-Board underlay levels it out to provide a perfect base for any floor covering.

Save time and effort during fitting with lightweight 1.2m x 1m tiles that are easy to lift and simple to cut and install.





## E-Board Timber Underlay



Available in

Code	Size	Thickness	Pallet QTY
QAU-EBT-01	1.2m x 1m (1.2m <sup>2</sup> )	12mm	50 sheets

Best for:

Level Floors

Sound Reduction

Commercial Use

Suitable for:

Heat Insulation



Top



Bottom



## E-Board Concrete Underlay



Available in

Code	Size	Thickness	Pallet QTY
QAU-EBC-01	1.2m x 1m (1.2m <sup>2</sup> )	9mm	75 sheets

Best for:

Level Floors

Sound Reduction

Commercial Use

Suitable for:

Heat Insulation



Top



Bottom



## E-Board Pro Underlay



Available in

Code	Size	Thickness	Pallet QTY
QAU-EBP-01	1.2m x 1m (1.2m <sup>2</sup> )	15mm	50 sheets

Minimum order quantity 50 sheets / 1 pallet

Best for:

Level Floors

Sound Reduction

Commercial Use

Suitable for:

Heat Insulation



Top



Bottom



# Acoustic Solutions



## Acoustic Solutions Heavy Traffic

Product	Density	Thickness	Impact Sound Reduction	Airborne Sound Insulation	Thermal Resistance
	kg/m <sup>3</sup>	mm	dB	dB	Tog Value
<b>SoundBarrier</b>		1	24		0.4
<b>Regupol Sonus 3912</b>	370 ± 5%	6	23		0.49
<b>Regupol Sonus 4515 Multi 3mm</b>	420 ± 5%	3	18		0.39
<b>Regupol Sonus 4515 Multi 4.5mm</b>	420 ± 5%	4.5	18		0.54
<b>Regupol Sonus 4515 Eco 3mm</b>	470 ± 5%	3	17		0.39
<b>Regupol Sonus 4515 Eco 4.5mm</b>	470 ± 5%	4.5	18		0.54
<b>Quiet Roll Standard 2mm</b>	250 ± 5%	2	20		0.3
<b>Quiet Roll Standard 5mm</b>	250 ± 5%	5	20		0.8
<b>Quiet Roll Universal</b>	145 - 220	2	On its own 17dB Under LVT 17dB Under laminate 20dB		0.53
<b>E-Board Timber</b>		12	22	49	
<b>E-Board Concrete</b>		9	24	47	
<b>E-Board Pro</b>		15	29	54	

All technical data provided in this publication is subject to variation. It is partly based on data from our suppliers and reflects the current level of industry expertise. It is not legally binding. Compliance with legal requirements remains the customer's own responsibility.



# Floor Levelling System

## Sub Floor Preparation



### Jumpax Basic Underlay

## High quality MDF free-floating floor levelling system.

**Jumpax Basic** is an extremely quick and cost-effective way to level your sub floor when compared with the traditional methods of screeding or ply boarding the sub floor.

### Easy does it

With a 3mm base and 4mm top board bound by a special interactive adhesive, Jumpax Basic is quick, clean and easy to install compared with traditional screeds. It preserves the sub-floor and allows you to lay the finished floor covering quicker, saving you time.

### Smooth, stable and simply warmer finish

The system is ideal for creating a sub-floor layer over underfloor heating systems for a perfect finish ready for the floor covering - with very low thermal resistance (0.7 tog) to really let heat through.

### Lightening the load

The lightweight MDF material means Jumpax Basic is a breeze to lift and manoeuvre, so with its quick and easy installation you'll really save time and effort.

### Impact sound reduction

Jumpax Basic has the added benefit of providing a sound reduction of 21dB (when installed over QA TechniBoard underlay) - see page 23.



# Jumpax Basic Underlay



Available in

Code	Size	Thickness	Pallet QTY
QAU-JPB-01	4 upper, 4 lower panels (2.88m <sup>2</sup> )/pack	3mm upper, 4mm lower panels (7mm overall)	48

Level Floors

Sound Reduction

Underfloor Heating

Commercial Use



Top

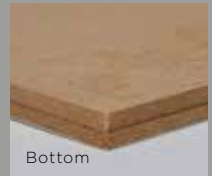

Bottom



# Floor Levelling System

## Sub Floor Preparation



## Flooring Grade Plywood Underlay

### High quality plywood for all **Flooring Grade applications.**

QA Flooring Grade Plywood is a Class 3 Exterior plywood which is engineered to meet and exceed the requirements for Flooring Grade plywood as set out in BS8203:2017.

#### **Quality first**

QA Flooring Grade Plywood is manufactured from high quality Malaysian hardwood, making it extremely durable and resistant to indentation and therefore fit for the demands of any flooring installation.

#### **Performance you can rely on**

A strict quality control process is applied in production to remove any defective timber and ensure reliable quality, meaning you can have confidence that the product will do as it says on the tin..

#### **Faster to fit**

Each sheet has position markers for the screws or nails to be applied, removing the need to mark up the positions manually which saves you time and effort on installation and helps to get the job done faster.

#### **Sustainably sourced**

QA Flooring Grade Plywood is produced using only PEFC certified timber, therefore supporting sustainably managed forests.

Please contact QA for installation guidelines and recommended screeds and adhesives.



BS8203:2017



# Flooring Grade Plywood

## Underlay

Available in

Code	Size	Thickness	Pallet QTY
QAA-PLY-01	2440mm x 1220mm (8' x 4')	5.5mm	150
QAA-PLY-02	1220mm x 1220mm (4' x 4')	5.5mm	150
QAA-PLY-03	2440mm x 1220mm (8' x 4')	9mm	100

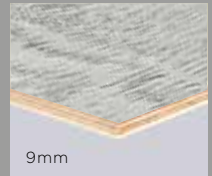
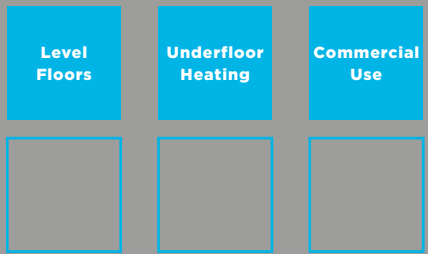



**Simply Better**

# Accessories



As a professional, these are  
the things you simply can't  
do without.  
The tools of your trade, the  
everyday items you rely on...

**and you can  
rely on QA  
to have a  
complete  
range of quality  
accessories  
that give you  
great value too.**



## Standard Profiles Accessories



To see the full range and colours available, scan the QR Code.

A range of quality silver, gold and matt black coloured screw-down profiles, sold in full box quantities, offering **superb** value.

### Single Edge

Protects the carpet edge for a neat finish.

Available in

Code	Length	Qty per carton	Colour
QAA-SSE-S1	0.9m	45	Silver
QAA-SSE-G1	0.9m	45	Gold
QAA-SSE-B1	0.9m	45	Matt Black
QAA-SSE-S2	2.7m	15	Silver
QAA-SSE-G2	2.7m	15	Gold
QAA-SSE-B2	2.7m	15	Matt Black



### Dual Grip

For a tidy, protected join between two carpets.

Available in

Code	Length	Qty per carton	Colour
QAA-SDG-S1	0.9m	45	Silver
QAA-SDG-G1	0.9m	45	Gold
QAA-SDG-B1	0.9m	45	Matt Black
QAA-SDG-S2	2.7m	15	Silver
QAA-SDG-G2	2.7m	15	Gold
QAA-SDG-B2	2.7m	15	Matt Black



## Cover Strip

Covers and protects on a wide range of floor coverings. Pleated and fluted - Colour matched fixing screws are included with the profiles for where the screw heads would be visible.

Available in

Code	Length	Qty per carton	Colour
QAA-SCS-S1	0.9m	45	Silver
QAA-SCS-G1	0.9m	45	Gold
QAA-SCS-S2	2.7m	15	Silver
QAA-SCS-G2	2.7m	15	Gold



A: 37mm

## Carpet Cover Strip

Angled ribs underneath pull into the pile and pull the two carpets together as the strip's screwed to the floor. Suitable for all types of carpet. Colour matched fixing screws are included with the profiles for where the screw heads would be visible.

Available in

Code	Length	Qty per carton	Colour
QAA-SCC-S1	0.9m	45	Silver
QAA-SCC-G1	0.9m	45	Gold
QAA-SCC-S2	2.7m	15	Silver
QAA-SCC-G2	2.7m	15	Gold

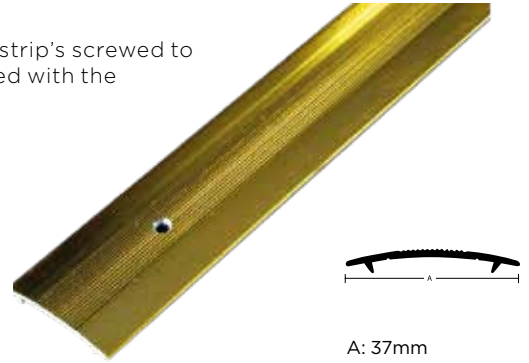

A: 37mm

## Extra Wide Cover Strip

Perfect for covering difficult joins between any floor coverings - one of the widest designs on the market. Colour matched fixing screws are included with the profiles for where the screw heads would be visible.

Available in

Code	Length	Qty per carton	Colour
QAA-SWC-S2	2.7m	15	Silver
QAA-SWC-G2	2.7m	15	Gold



A: 61mm



## 9mm Z Section

For a neat join where laminated smooth flooring meets carpet. Lightly tap on top of the strip with a rubber mallet after fitting for a snug fit to edges of floor coverings.

Available in

Code	Length	Qty per carton	Colour
QAA-SZS-S1	0.9m	45	Silver
QAA-SZS-G1	0.9m	45	Gold
QAA-SZS-B1	0.9m	45	Matt Black
QAA-SZS-S2	2.7m	15	Silver
QAA-SZS-G2	2.7m	15	Gold
QAA-SZS-B2	2.7m	15	Matt Black

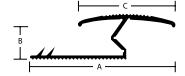
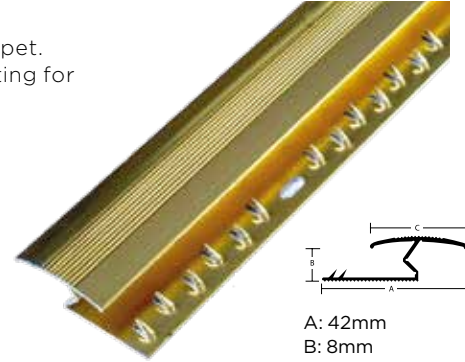

A: 42mm  
B: 8mm  
C: 28mm

## 14mm Z Section

A larger version of our Standard 9mm Z Section designed for thicker wood and carpet.

Available in

Code	Length	Qty per carton	Colour
QAA-SZP-S2	2.7m	10	Silver
QAA-SZP-G2	2.7m	10	Gold

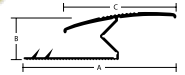
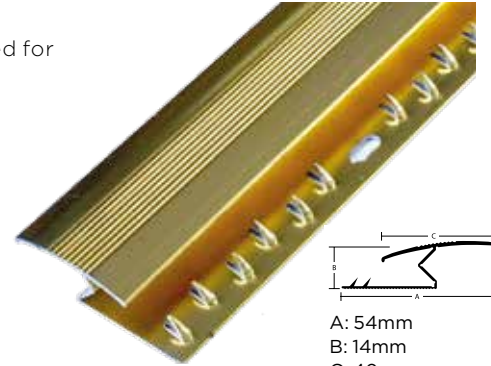

A: 54mm  
B: 14mm  
C: 40mm

## Vinyl Edge

Neatens and protects the edge of resilient vinyl floor coverings up to 4mm thick. Colour matched fixing screws are included with the profiles for where the screw heads would be visible.

Available in

Code	Length	Qty per carton	Colour
QAA-SVE-S1	0.9m	45	Silver
QAA-SVE-G1	0.9m	45	Gold
QAA-SVE-S2	2.7m	15	Silver
QAA-SVE-G2	2.7m	15	Gold

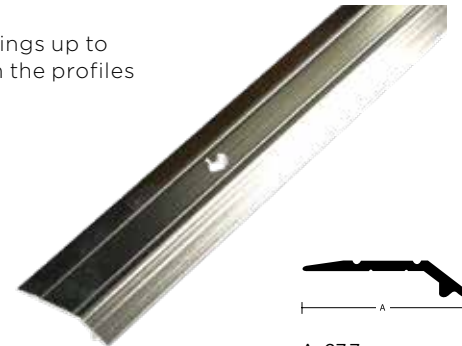

A: 27.7mm



# Self Adhesive Profiles

## Accessories



To see the full range and colours available, scan the QR Code.

A fantastic collection of silver, gold and matt black coloured profiles, sold in full boxes. All products are **self-adhesive** for faster fitting and convenience.

### 8mm Angle Edge

For a smooth join to resilient floor coverings. Quick and easy to install.

Available in

Code	Length	Qty per carton	Colour
QAA-AAE-S1	0.9m	30	Matt Silver
QAA-AAE-G1	0.9m	30	Matt Gold
QAA-AAE-B1	0.9m	30	Matt Black
QAA-AAE-S2	2.7m	10	Matt Silver
QAA-AAE-G2	2.7m	10	Matt Gold
QAA-AAE-B2	2.7m	10	Matt Black

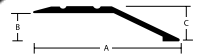

A: 43mm  
B: 8mm  
C: 10mm

### 14mm Angle Edge

A 14mm version of the Self Adhesive 8mm Angle Edge.

Available in

Code	Length	Qty per carton	Colour
QAA-AAN-S2	2.7m	10	Matt Silver
QAA-AAN-G2	2.7m	10	Matt Gold

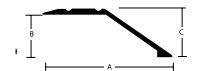
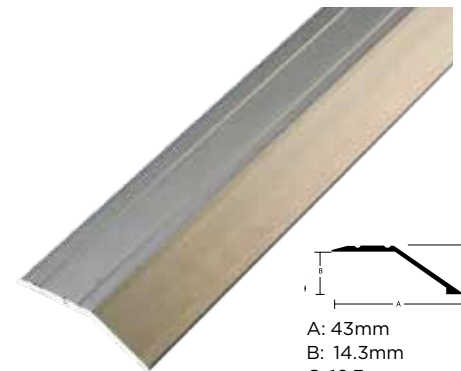

A: 43mm  
B: 14.3mm  
C: 16.3mm



## 20mm Angle Edge

The largest version of our Self Adhesive 8mm Angle Edge.

Available in

Code	Length	Qty per carton	Colour
QAA-AX-S2	2.7m	10	Matt Silver
QAA-AX-G2	2.7m	10	Matt Gold

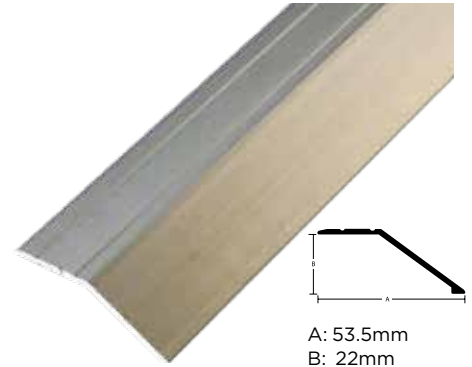

A: 53.5mm  
B: 22mm

## Euro Cover Strip

A high quality, easy to install cover strip for most floor coverings of equal level.

Available in

Code	Length	Qty per carton	Colour
QAA-AEC-S1	0.9m	30	Matt Silver
QAA-AEC-G1	0.9m	30	Matt Gold
QAA-AEC-B1	0.9m	30	Matt Black
QAA-AEC-S2	2.7m	10	Matt Silver
QAA-AEC-G2	2.7m	10	Matt Gold
QAA-AEC-B2	2.7m	10	Matt Black

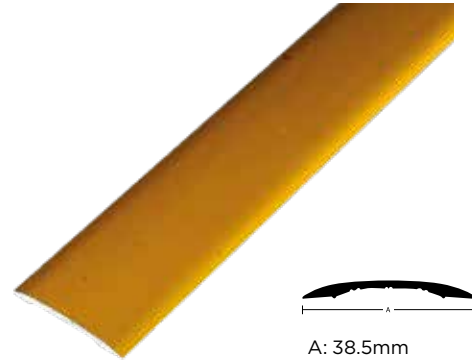

A: 38.5mm

## 9mm Nosing

A quick and easy to use choice for wood/laminate. Ideal for a neat finish.

Available in

Code	Length	Qty per carton	Colour
QAA-ANO-S1	0.9m	30	Matt Silver
QAA-ANO-G1	0.9m	30	Matt Gold
QAA-ANO-B1	0.9m	30	Matt Black
QAA-ANO-S2	2.7m	10	Matt Silver
QAA-ANO-G2	2.7m	10	Matt Gold
QAA-ANO-B2	2.7m	10	Matt Black

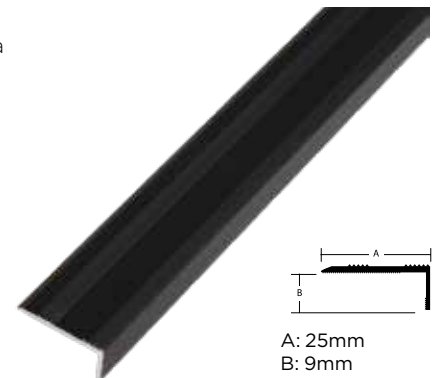

A: 25mm  
B: 9mm

## 15mm Nosing

An ideal choice for wood/laminate, with the advantage of quick and easy self adhesive fixing.

Available in

Code	Length	Qty per carton	Colour
QAA-ANX-S2	2.7m	10	Matt Silver
QAA-ANX-G2	2.7m	10	Matt Gold

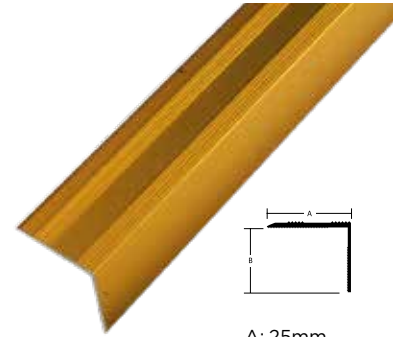

A: 25mm  
B: 15mm

## 20mm Nosing

A larger version of our 9mm and 15mm Nosings.

Available in

Code	Length	Qty per carton	Colour
QAA-ANZ-S2	2.7m	10	Matt Silver
QAA-ANZ-G2	2.7m	10	Matt Gold



A: 25mm  
B: 20mm





## Specialist Profiles Accessories



To see the full range and colours available, scan the QR Code.

Choose our Specialist range for fantastic quality combined with faster fitting. All profiles in this collection are **self-adhesive** and are available in either single lengths or full boxes. Offering a wide variety of wood colour options, with certified AC3 rating for scratch resistance, to provide the perfect solution for that finishing touch to a new floor.

### 2mm - 18mm Adjustable Ramp

Available in

Code	Length	Qty per carton	Colour
QAA-FAR-01	0.9m	15	Brushed Steel
QAA-FAR-02	0.9m	15	Matt Silver
QAA-FAR-03	0.9m	15	Matt Gold
QAA-FAR-04	0.9m	15	Light Oak
QAA-FAR-05	0.9m	15	Dark Oak
QAA-FAR-06	0.9m	15	Country Oak
QAA-FAR-07	0.9m	15	Grey Oak
QAA-FAR-08	0.9m	15	Beige Grey Oak
QAA-FAR-09	0.9m	15	Tigua
QAA-FAR-10	0.9m	15	Oak Crème
QAA-FAR-11	0.9m	15	Light Grey Oak
QAA-FAR-12	0.9m	15	Walnut

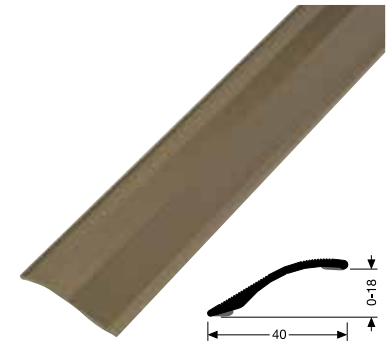

Code	Length	Qty per carton	Colour
QAA-FAR-13	2.7m	10	Matt Silver
QAA-FAR-14	2.7m	10	Matt Gold
QAA-FAR-15	2.7m	10	Brushed Steel
QAA-FAR-16	2.7m	10	Light Oak
QAA-FAR-17	2.7m	10	Dark Oak
QAA-FAR-18	2.7m	10	Country Oak
QAA-FAR-19	2.7m	10	Grey Oak
QAA-FAR-20	2.7m	10	Beige Grey Oak
QAA-FAR-21	2.7m	10	Tigua
QAA-FAR-22	2.7m	10	Oak Crème
QAA-FAR-23	2.7m	10	Light Grey Oak
QAA-FAR-24	2.7m	10	Walnut





## Cover Strip

Covers and protects on a wide range of floor coverings.  
Pleated and fluted.

Available in

Code	Length	Qty per carton	Colour
QAA-FCS-01	0.9m	15	Matt Silver
QAA-FCS-02	0.9m	15	Matt Gold
QAA-FCS-03	0.9m	15	Light Oak
QAA-FCS-04	0.9m	15	Dark Oak
QAA-FCS-05	0.9m	15	Country Oak
QAA-FCS-06	0.9m	15	Grey Oak
QAA-FCS-07	0.9m	15	Beige Grey Oak
QAA-FCS-08	0.9m	15	Tigua
QAA-FCS-09	0.9m	15	Oak Crème
QAA-FCS-10	0.9m	15	Light Grey Oak
QAA-FCS-11	0.9m	15	Walnut
QAA-FCS-23	0.9m	15	Brushed Steel

Code	Length	Qty per carton	Colour																											
QAA-FCS-12	2.7m	10	Matt Silver																											
QAA-FCS-13	2.7m	10	Matt Gold																											
QAA-FCS-14	2.7m	10	Light Oak																											
QAA-FCS-15	2.7m	10	Dark Oak																											
QAA-FCS-16	2.7m <td 10	Country Oak	QAA-FCS-17	2.7m	10	Grey Oak	QAA-FCS-18	2.7m	10	Beige Grey Oak	QAA-FCS-19	2.7m	10	Tigua	QAA-FCS-20	2.7m	10	Oak Crème	QAA-FCS-21	2.7m	10	Light Grey Oak	QAA-FCS-22	2.7m	10	Walnut	QAA-FCS-24	2.7m	10	Brushed Steel
QAA-FCS-17	2.7m	10	Grey Oak																											
QAA-FCS-18	2.7m	10	Beige Grey Oak																											
QAA-FCS-19	2.7m	10	Tigua																											
QAA-FCS-20	2.7m	10	Oak Crème																											
QAA-FCS-21	2.7m	10	Light Grey Oak																											
QAA-FCS-22	2.7m	10	Walnut																											
QAA-FCS-24	2.7m	10	Brushed Steel																											

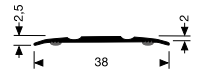
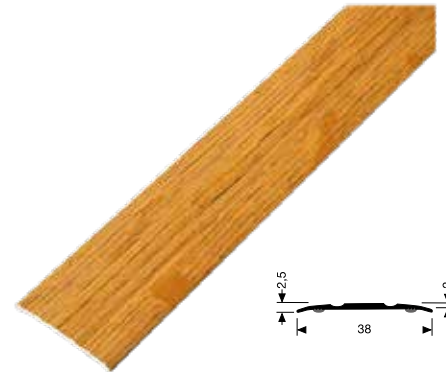
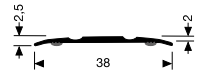

## 10mm End Section

Available in

Code	Length	Qty per carton	Colour
QAA-FES-01	0.9m	15	Matt Silver
QAA-FES-02	0.9m	15	Matt Gold
QAA-FES-03	0.9m	15	Brushed Steel
QAA-FES-04	0.9m	15	Light Oak
QAA-FES-05	0.9m	15	Dark Oak
QAA-FES-06	0.9m	15	Country Oak
QAA-FES-07	0.9m	15	Grey Oak
QAA-FES-08	0.9m	15	Beige Grey Oak
QAA-FES-09	0.9m	15	Tigua
QAA-FES-10	0.9m	15	Oak Crème
QAA-FES-11	0.9m	15	Light Grey Oak
QAA-FES-12	0.9m	15	Walnut

Code	Length	Qty per carton	Colour
QAA-FES-13	2.7m	10	Matt Silver
QAA-FES-14	2.7m	10	Matt Gold
QAA-FES-15	2.7m	10	Brushed Steel
QAA-FES-16	2.7m	10	Light Oak
QAA-FES-17	2.7m	10	Dark Oak
QAA-FES-18	2.7m	10	Country Oak
QAA-FES-19	2.7m	10	Grey Oak
QAA-FES-20	2.7m	10	Beige Grey Oak
QAA-FES-21	2.7m	10	Tigua
QAA-FES-22	2.7m	10	Oak Crème
QAA-FES-23	2.7m	10	Light Grey Oak
QAA-FES-24	2.7m	10	Walnut

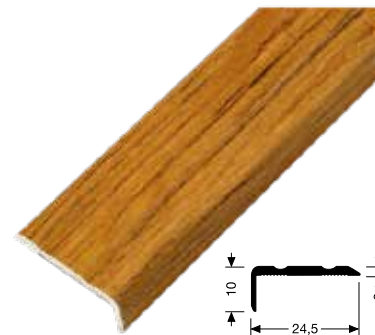

## 20mm Stair Nosing

Available in

Code	Length	Qty per carton	Colour
QAA-FSN-01	0.9m	15	Matt Silver
QAA-FSN-02	0.9m	15	Matt Gold
QAA-FSN-03	0.9m	15	Brushed Steel
QAA-FSN-04	0.9m	15	Light Oak
QAA-FSN-05	0.9m	15	Dark Oak
QAA-FSN-06	0.9m	15	Country Oak
QAA-FSN-07	0.9m	15	Grey Oak
QAA-FSN-08	0.9m	15	Beige Grey Oak
QAA-FSN-09	0.9m	15	Tigua
QAA-FSN-10	0.9m	15	Oak Crème
QAA-FSN-11	0.9m	15	Light Grey Oak
QAA-FSN-12	0.9m	15	Walnut

Code	Length	Qty per carton	Colour
QAA-FSN-15	2.7m	10	Matt Silver
QAA-FSN-13	2.7m	10	Matt Gold
QAA-FSN-14	2.7m	10	Brushed Steel
QAA-FSN-16	2.7m	10	Light Oak
QAA-FSN-17	2.7m	10	Dark Oak
QAA-FSN-18	2.7m	10	Country Oak
QAA-FSN-19	2.7m	10	Beige Grey Oak
QAA-FSN-20	2.7m	10	Tigua
QAA-FSN-21	2.7m	10	Oak Crème
QAA-FSN-22	2.7m	10	Light Grey Oak
QAA-FSN-23	2.7m	10	Grey Oak
QAA-FSN-24	2.7m	10	Walnut



## Z Section

For a neat join where laminated smooth flooring meets carpet. Lightly tap on top of the strip with a rubber mallet after fitting for a snug fit to edges of floor coverings.

Available in

Code	Length	Qty per carton	Colour
QAA-FZS-01	0.9m	15	Matt Silver
QAA-FZS-02	0.9m	15	Matt Gold
QAA-FZS-03	0.9m	15	Brushed Steel
QAA-FZS-04	0.9m	15	Light Oak
QAA-FZS-05	0.9m	15	Dark Oak
QAA-FZS-06	0.9m	15	Country Oak
QAA-FZS-07	0.9m	15	Grey Oak
QAA-FZS-08	0.9m	15	Light Grey Oak
QAA-FZS-09	0.9m	15	Walnut
QAA-FZS-19	0.9m	15	Beige Grey Oak
QAA-FZS-21	0.9m	15	Tigua
QAA-FZS-23	0.9m	15	Oak Crème



Code	Length	Qty per carton	Colour																																			
QAA-FZS-10	2.7m	10	Matt Silver																																			
QAA-FZS-11	2.7m	10	Matt Gold																																			
QAA-FZS-12	2.7m <td 10	Brushed Steel	QAA-FZS-13	2.7m	10	Light Oak	QAA-FZS-14	2.7m	10	Dark Oak	QAA-FZS-15	2.7m	10	Country Oak	QAA-FZS-16	2.7m	10	Grey Oak	QAA-FZS-17	2.7m	10	Light Grey Oak	QAA-FZS-18	2.7m	10	Walnut	QAA-FZS-20	2.7m	10	Beige Grey Oak	QAA-FZS-22	2.7m	10	Tigua	QAA-FZS-24	2.7m	10	Oak Crème
QAA-FZS-13	2.7m	10	Light Oak																																			
QAA-FZS-14	2.7m	10	Dark Oak																																			
QAA-FZS-15	2.7m	10	Country Oak																																			
QAA-FZS-16	2.7m	10	Grey Oak																																			
QAA-FZS-17	2.7m	10	Light Grey Oak																																			
QAA-FZS-18	2.7m	10	Walnut																																			
QAA-FZS-20	2.7m	10	Beige Grey Oak																																			
QAA-FZS-22	2.7m	10	Tigua																																			
QAA-FZS-24	2.7m	10	Oak Crème																																			





# LVT TRANSITION PROFILE

The new QA LVT Transition Profile is the perfect solution for concealing joins between 2 different LVT floors of the same height, as well as expansion breaks in floating floors, across doorways, and floors covering large surface areas. By inserting a strip of the actual LVT being fitted, into the profile channel, this ensures only a neat tramline is visible giving a much smarter, more premium finish than a coloured profile. The new QA LVT Transition Profile is self-adhesive for an easy, clean installation.

## 2 Sizes available:

QAA-LTS-S1

LVT Transition Self Adhesive

45 lengths per box x 0.9m

QAA-LTS-S2

LVT Transition Self Adhesive

15 lengths per tube x 2.7m

Also available in single lengths.

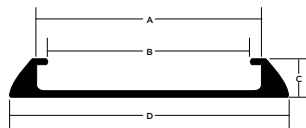

A: 23.9mm  
B: 21.5mm  
C: 4.1mm  
D: 29.8mm



LVT strip not included



# Premium Profiles



Add that extra touch of finesse to your installations with our range of exquisite **Premium Profiles** available in Chrome, Black Nickel and Brushed finishes.



# Premium Profiles

## Accessories



To see the full range and colours available, scan the QR Code.

Superior quality, premium finish profiles for **luxury** installations that require the best. Available in a selection of indulgent metal colour options - Chrome, Black Nickel and Brushed - and a combination of screw down and self-adhesive applications.

**Available in full boxes and single lengths.**

### Dual Grip

Screw down fixture for a tidy, protected joint between two carpets. Available in single lengths or tubes of 5 lengths.

Avai

Code	Length	Qty per carton	Colour
QAA-PDG-01	0.9m	5	Chrome
QAA-PDG-02	2.7m	5	Chrome
QAA-PDG-03	0.9m	5	Black Nickel
QAA-PDG-04	2.7m	5	Black Nickel
QAA-PDG-05	0.9m	5	Brushed
QAA-PDG-06	2.7m	5	Brushed

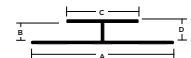

A: 60mm  
B: 8mm  
C: 30mm  
D: 10mm

### Single Edge

Screw down fixture - Protects the carpet edge for a neat finish. Available in single lengths or tubes of 5 lengths.

Available in

Code	Length	Qty per carton	Colour
QAA-PSE-01	0.9m	5	Chrome
QAA-PSE-02	2.7m	5	Chrome
QAA-PSE-03	0.9m	5	Black Nickel
QAA-PSE-04	2.7m	5	Black Nickel
QAA-PSE-05	0.9m	5	Brushed
QAA-PSE-06	2.7m	5	Brushed

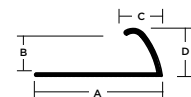

A: 40mm  
B: 12mm  
C: 11.9mm  
D: 15mm



## Adjustable Ramp

Self-adhesive fixture used to conceal height differences between two floor coverings. Available in single lengths or tubes of 5 lengths.

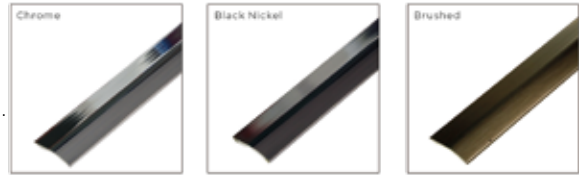

Available in

Code	Length	Qty per carton	Colour
QAA-PAR-01	0.9m	5	Chrome
QAA-PAR-02	2.7m	5	Chrome
QAA-PAR-03	0.9m	5	Black Nickel
QAA-PAR-04	2.7m	5	Black Nickel
QAA-PAR-05	0.9m	5	Brushed
QAA-PAR-06	2.7m	5	Brushed

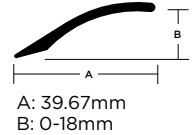

## Z-Section

Screw down fixture for a neat join where laminated smooth flooring meets carpet. Lightly tap on top of the strip with a rubber mallet after fitting for a snug fit to edges of floor coverings. Available in single lengths or tubes of 5 lengths.



Available in

Code	Length	Qty per carton	Colour
QAA-PZS-01	0.9m	5	Chrome
QAA-PZS-02	2.7m	5	Chrome
QAA-PZS-03	0.9m	5	Black Nickel
QAA-PZS-04	2.7m	5	Black Nickel
QAA-PZS-05	0.9m	5	Brushed
QAA-PZS-06	2.7m	5	Brushed

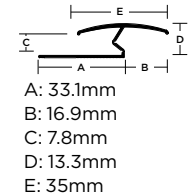

## Euro Cover Strip

Self adhesive fixture - A high quality, easy to install cover strip for most floor coverings of equal level. Available in single lengths or tubes of 5 lengths.

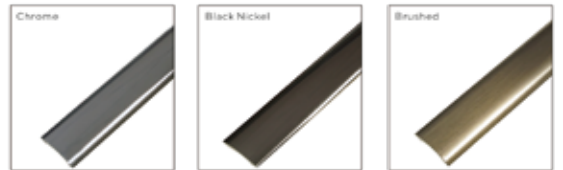

Available in

Code	Length	Qty per carton	Colour
QAA-PEC-01	0.9m	5	Chrome
QAA-PEC-02	2.7m	5	Chrome
QAA-PEC-03	0.9m	5	Black Nickel
QAA-PEC-04	2.7m	5	Black Nickel
QAA-PEC-05	0.9m	5	Brushed
QAA-PEC-06	2.7m	5	Brushed







## Scotia

Bridges the expansion gaps on laminate, engineered, and solid wood floors for a truly **professional finish.**

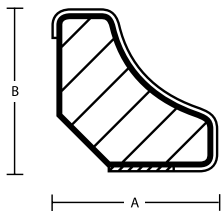

A: 16.5mm B: 16.5mm



## Did You Know?

You can paint our White Scotia (QAA-SCH-31) any colour you choose to match the colour of your skirting boards.



Available in

Product Code	Length	Qty per carton	Colour
QAA-SCH-01	2.4m	50	Almond Oak
QAA-SCH-02	2.4m	50	Antique Oak
QAA-SCH-03	2.4m	50	Arctic Oak
QAA-SCH-04	2.4m	50	Bedrock Oak
QAA-SCH-05	2.4m	50	Boulder Oak
QAA-SCH-06	2.4m	50	Castello Oak
QAA-SCH-07	2.4m	50	Corsica Oak
QAA-SCH-08	2.4m	50	Dark Planked Oak 112
QAA-SCH-09	2.4m	50	Dark Varnished Oak Planks 293
QAA-SCH-10	2.4m	50	Fiji Oak
QAA-SCH-11	2.4m	50	Frosted Oak
QAA-SCH-12	2.4m	50	Ginger Oak
QAA-SCH-13	2.4m	50	Granite
QAA-SCH-14	2.4m	50	Harvest Oak
QAA-SCH-15	2.4m	50	Light Varnished Oak
QAA-SCH-16	2.4m	50	Lofoten Walnut
QAA-SCH-17	2.4m	50	Loxley Oak
QAA-SCH-18	2.4m	50	Magnolia Oak
QAA-SCH-19	2.4m	50	Natural Oiled Oak
QAA-SCH-20	2.4m	50	Oak 654493
QAA-SCH-21	2.4m	50	Oak FOEI03
QAA-SCH-22	2.4m	50	Oak FOEI032
QAA-SCH-23	2.4m	50	Old Grey Planked Oak
QAA-SCH-24	2.4m	50	Poppy Oak
QAA-SCH-25	2.4m	50	Prestige Oak
QAA-SCH-26	2.4m	50	Slate
QAA-SCH-27	2.4m	50	Titanium Oak
QAA-SCH-28	2.4m	50	Varnished White Oak
QAA-SCH-29	2.4m	50	Virginia Chestnut
QAA-SCH-30	2.4m	50	Virginia Walnut
QAA-SCH-31	2.4m	50	White
QAA-SCH-32	2.4m	50	White Oak
QAA-SCH-33	2.4m	50	Worn Oak
QAA-SCH-34	2.4m	50	Washed Grey Oak
QAA-SCH-35	2.4m	50	Walnut
QAA-SCH-36	2.4m	50	Washed Light Grey

Available in full boxes only.



# Standard Gripper Accessories

QA Standard Gripper offers premium performance with variants to suit every carpet and subfloor, domestic and contract use. With a pronounced bevel edge for an easy and consistent roll edge finish, it's made from high quality 6.5mm deep x 20mm wide 5-ply plywood with zinc plated nails and galvanised pins – giving exceptional carpet holding strength.

## 3 Floor Nail Specifications

Dual Purpose Nail, Concrete Nail, Wood Nail Gripper. 2 Pin Heights. Short Pin 3.2mm (1/8") – for cord carpeting and some low tuft carpets. Medium Pin 4.8mm (3/6") – the more usual pin length, suitable for most types of carpet.

## Standard Dual Purpose Gripper

Pre-nailed with dual purpose nails for wood and concrete subfloors.

## Standard Concrete Nail Gripper

Pre-nailed with masonry nails, specially designed for ease and speed of installation and an exceptionally strong fixing on concrete subfloors.

## Standard Wood Nail Gripper

Pre-nailed with specially tempered nails (threaded for ultimate holding power), for easy, fast installation on board and suspended timber subfloors.

Available in

Code	Nail	Pin Height	Size	Boxed	Pallet QTY
QAA-GST-DS	Dual	Short	5ft	500ft/box	50 boxes/pallet
QAA-GST-DN	Dual	Medium	5ft	500ft/box	50 boxes/pallet
QAA-GST-CN	Concrete	Medium	5ft	500ft/box	50 boxes/pallet
QAA-GST-WN	Wood	Medium	5ft	500ft/box	50 boxes/pallet





## Premium Gripper Accessories

Rated **the best** by fitters.

Premium Gripper from QA Flooring Solutions is regarded by many fitters as their favourite choice when it comes to using a top-of-the-range gripper product. QA Premium Gripper is suitable for all types of luxury carpet installation and is ideal for high quality carpets. QA Premium Gripper has 50% more pins per length than our QA Standard Gripper and is 6.5mm deep x 30mm wide - giving better strength and stability so you can be sure that the installation will be perfect and trouble free every time. QA Premium Gripper is available in all nail options - dual purpose, wood and concrete. It comes in 5ft lengths and 400ft per box.



30mm wide for added strength and stability

### Premium Dual Purpose Gripper

Pre-nailed with dual purpose nails for wood and concrete subfloors.

### Premium Concrete Nail Gripper

Pre-nailed with masonry nails, specially designed for ease and speed of installation and an exceptionally strong fixing on concrete subfloors.

### Premium Wood Nail Gripper

Pre-nailed with specially tempered nails (threaded for ultimate holding power), for easy, fast installation on board and suspended timber subfloors.





## Deep Base Gripper Accessories

QA Deep Base Gripper is ideal for installations with thicker underlays (10-12mm) which prevents any dips forming around the perimeter of the room.

This extra thick carpet gripper ensures a stronger hold to your carpets.

### Deep Base Specifications

Our extra deep gripper is 9mm high instead of standard 6.5mm this will help to reduce any height difference.

Available in medium pin - nails and pins are 4mm longer to allow for the extra thickness of the wood.

All QA gripper is made from high quality 5-ply plywood with zinc plated nails and galvanised pins - giving exceptional carpet holding strength.



Available in

Code	Nail	Pin Height	Size	Boxed	Pallet QTY
QAA-GED-CN	Concrete	Medium	5ft	500ft/box	35 boxes/pallet
QAA-GED-WN	Wood	Medium	5ft	500ft/box	35 boxes/pallet





## Adhesives Accessories

**A choice** of adhesives for a variety of different applications.

### Heavy Duty Spray Adhesive

Suitable for most flooring applications including carpets, carpet tiles, underlays and textiles. Sticks to timber, chipboard, ceramic, stone, concrete, masonry, metals, most plastics, glass and rubber.



Available in

Code	Can Content	Box Quantity	Pallet QTY
QAA-ADH-SA	500ml	12 cans	144 boxes

### Strong Grip Gripper Adhesive

A high quality, gunnable adhesive – ideal for gap filling, fixing stair nosings door strips and carpet grippers to most flooring surfaces and refitting skirting boards and covings. The approximate curing time is 24 hours.



Available in

Code	Can Content	Box Quantity	Pallet QTY
QAA-ADH-GA	350ml	12 tubes	48 boxes

### Fast Set Super Gripper Adhesive

A powerful, fast-setting, polyurethane adhesive ideal for fixing stair nosings, door strips, and carpet grippers to most floor surfaces. Exceptionally fast initial grab, with skin formation time of approx. 3 minutes and a setting time of 8 to 10 minutes.



Available in

Code	Can Content	Box Quantity	Pallet QTY
QAA-ADH-FG	350ml	12 tubes	48 boxes



Our Tapes are specially designed to give a strong, stable fixing that exceeds **British Standards** for various types of carpets and installations.

### Gold Heatseam Tape

Perfect for conventional woven or secondary jute back carpets in light traffic areas - the metallised gold foil backing reduces heat loss into the floor, melting the adhesive more rapidly for faster seaming. It also slows down adhesive cooling giving you more time for pattern matching and allowing better control at lower temperatures for sensitive carpet piles and backings.

Available in

Code	Size	Box QTY
QAA-TAP-GO	101.6mm x 20m	10 rolls



### Double Sided Tape

Heavy duty double sided tape for securing felt backed carpets and other floor coverings.

Available in

Code	Size	Box QTY
QAA-TAP-DS	50mm x 50m	24 rolls



### Anti Plas Tape

Special double sided tape for vinyl flooring that doesn't allow adhesive from the tape to transfer to the vinyl (unlike standard Double Sided Tape).

Available in

Code	Size	Box QTY
QAA-TAP-AP	50mm x 50m	24 rolls



## Vapour Tape

A self adhesive seaming tape that creates an effective moisture barrier with improved joint seal protection and also strengthens underlay joints.

Available in

Code	Size	Box QTY
QAA-TAP-VA	75mm x 25m	20 rolls



## Barrier Jointing Tape

A jointing tape that can be used with the Barrier wood underlays for added joint seal protection and also giving the underlay extra strength and stability.

Available in

Code	Size	Box QTY
QAA-TAP-BA	50mm x 15m	50 rolls







## Tools - General Purpose Accessories

A range of **premium quality tools** for everyday general use.

### Shark Knife

A general purpose safety knife featuring ergonomic hand protection and easy blade access. Comes complete with strong plastic holster and belt clip.

Available in

Code	QTY
QAA-TOG-DK	1



### Steel Blades

Packed in strong plastic boxes for extra safety.

Available in

Code	Type	Box QTY
QAA-TOG-HD	Heavy Duty Straight Edge	100 per box
QAA-TOG-HO	Hooked	100 per box
QAA-TOG-CO	Concave	100 per box





### Small Damp-Proof Polythene Membrane

Highly resistant to puncturing and suitable for use with underfloor heating systems, this protects against damp from concrete subfloors. It can be used either as an oversite membrane between a blinded hardcore bed and base concrete, or as a sandwich membrane in base concrete or between it and the screed.

Available in

Code	Size	Gauge	Pack Quantity	Pallet QTY
QAA-DPM-SC	2m x 5m (10m <sup>2</sup> )	1000G	1	100



### Water Vapour Barrier

The perfect extra protection under wood flooring, this puncture-resistant barrier comes in a handy multifold pack and can be used with underfloor heating systems.

Available in

Code	Size	Gauge	Pack Quantity	Pallet QTY
QAA-DPM-VB	5m x 4m (20m <sup>2</sup> )	600G	5 per Box	180 Packs





## Handywrap and Dispenser

Ideal for stretch wrapping loose bundles of products or carpet rolls, rugs and scotia, for example. Dispenser available for easier handling.

Available in

Code	Size	Box Quantity
QAA-PAC-HW	100mm x 300m x 15 micron	30 rolls
Code	Size	Quantity
QAA-PAC-HD	Handywrap Dispenser	1



## Palletwrap

Heavy duty, maximum strength wrap for protecting and stabilising palletised items. Available in clear and black.

Available in

Code	Size	Box Quantity
QAA-PAC-PW	400mm x 300m x 17micron	6 rolls





**QA Flooring Solutions Ltd**

Unit 2, Hurricane Drive, Liverpool, L24 8RL

Tel: 0151 495 3434

Fax: 0151 427 0484

Email: [sales@qaflooringsolutions.com](mailto:sales@qaflooringsolutions.com)

**[www.qaflooringsolutions.com](http://www.qaflooringsolutions.com)**