



Simply Better

Underlays & Accessories Directory

Issue 23



WELCOME TO QA

QA FLOORING SOLUTIONS IS ONE OF THE WORLD'S LEADING MANUFACTURERS AND DISTRIBUTORS OF LVT FLOORING, UNDERLAY AND ACCESSORIES.

In the UK, we operate a large distribution centre with capacity to provide next day delivery if required.

Our growth has been achieved through our relentless focus to be 'Simply Better' than our competitors by producing innovative and highly desirable products, delivering world class service and critically, selling products that suit every application and budget.

Keeping it simple. Always being better... That's what QA is all about.

The QA Team



CONTENTS

- 2 Welcome To QA
- 3 Contents
- 4 6 Great Reasons
- 5 How To Order
- 6 Online Ordering
- 8 Our Warranty
- 9 Where We Are
- 10 Marketing Support
- 11 Traffilay System

Underlays

- 12 Wood Underlay Introduction
- 14 Wood Underlays
- 33 Wood Underlay Technical Information
- 34 Carpet Underlay Introduction
- 36 Carpet Underlays
- 57 Carpet Underlay Technical Information
- 58 Acoustic Solutions Introduction
- 60 Acoustic Solutions
- 69 Acoustic Solutions Technical Information

Floor Levelling System

- 70 Floor Levelling System

Accessories

- 72 Accessories Introduction
- 76 Standard Profiles
- 79 Self Adhesive Profiles
- 82 Specialist Profiles
- 87 Display Stands
- 88 Premium Profiles
- 92 Scotia Beading
- 94 Standard Gripper
- 95 Premium Gripper
- 96 Adhesives
- 97 Tapes
- 99 Tools
- 100 Paper & Polythene
- 102 Packaging

6 GREAT REASONS TO LOVE QA



For all orders over **£400.00 + VAT** free delivery is available.



Our huge range makes sourcing all your flooring needs easy! With our products in stock we're the perfect single source partner.



NEXT DAY DELIVERY available on request.



If there's anything you're not happy with - we'll put it right. **QUICKLY, HONESTLY AND GENEROUSLY.**

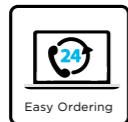

Whether it be phone, online or email, our service is geared to your convenience the moment you make contact - **EXPERIENCE IT TODAY!**



One of the biggest stock holdings of underlay and accessories in the UK.

HOW TO ORDER



0151 495 3434



sales@qaflooringsolutions.com



0151 427 0484



www.qaflooringsolutions.com

All orders are accepted subject to our Terms and Conditions of Sale - a copy of these is available on request.

Our Delivery Service

We offer a standard 2-3 day delivery service with next day delivery available if required. We also offer a range of delivery options, from timed deliveries to home address and site drops so you can be sure that you get your goods on time!

Delivery Options

- Standard delivery **FREE** over **£400**
- Below minimum order value **£30**
- Next day delivery **£35**
- Delivery to building site / home address **£48**
- AM / before 12pm **£50**
- Saturday / same day P.O.A.
- Outside mainland UK / export P.O.A.

Delivery cost correct at time of print and may be subject to change.

★REVIEWS WHAT DO OUR CUSTOMERS SAY?

'Great service and prices, never had an issue.' 'Happy with your service and your products.'
Flooring retailer, London

'Excellent customer service, rapid responses to emails and orders placed... Would recommend!'
Flooring retailer, France

'Very efficient, prompt and reliable service that we can trust and rely upon.'
Flooring retailer, North Wales

ONLINE ORDERING



You can now order online at our trade only portal which can be found at: trade.qaflooringsolutions.com

Contact your Account Manager to get set up today!

BENEFITS OF ORDERING ONLINE

Order at your convenience using our online portal and you can...

- ✓ Check current stock levels so you can plan your jobs with confidence
- ✓ Quickly re-order frequently purchased products by accessing them through your Saved Items
- ✓ Access your invoices, credit details and other accounting information
- ✓ View technical data / COSH sheets and instruction documents

Order ONLINE NOW through our trade portal.
trade.qaflooringsolutions.com

[Speak to your Account Manager or contact 0151 495 3434 to gain access to our online portal](#)

OUR WARRANTY

IF THERE'S ANYTHING YOU'RE NOT HAPPY WITH - WE'LL PUT IT RIGHT. QUICKLY, HONESTLY AND GENEROUSLY.



No hassle. No unanswered calls. No loose ends. You simply want to know you can trust the products and people you're dealing with. After all, it could be your trade reputation at stake - or the comfort of your home.

With QA, you can expect guaranteed reliability - every time.

When we say we offer you a complete flooring solution, we mean it, and we'll go the extra mile to make sure you're happy with every aspect of our service.

And even though we've got over 300 product options, whatever you get from us is covered by one straightforward warranty.

WHERE WE ARE



IN THE UK, WE OPERATE FROM A LARGE DISTRIBUTION CENTRE, A SHORT DISTANCE FROM OUR HEAD OFFICE IN LIVERPOOL, COVERING THE WHOLE OF THE UK AND REPUBLIC OF IRELAND.

All technical data provided in this publication is subject to variation. It is partly based on data from our suppliers and reflects the current level of industry expertise. It is not legally binding. Compliance with legal requirements remains the customer's own responsibility.

MARKETING SUPPORT

WE OFFER A WIDE RANGE OF POS TO HELP INCREASE YOUR SALES, INCLUDING:

- Product Directories
- Sample Boards
- Hanging Samples
- Sample Books
- Profile Display Stands

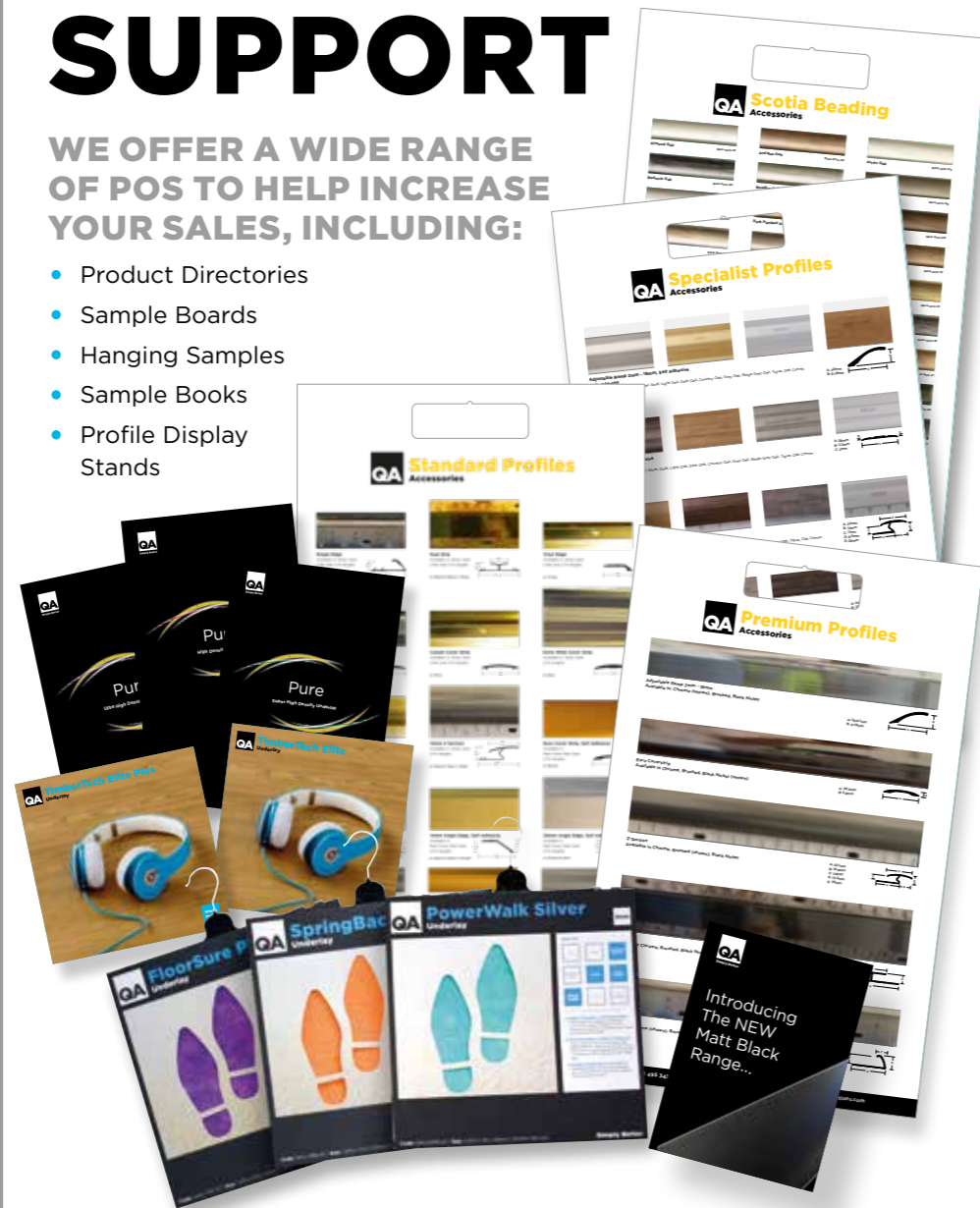

TRAFFILAY

A SIMPLY BETTER WAY TO FIND YOUR PERFECT UNDERLAY.

How Traffilay works

Having decided on your floor covering (wood, carpet, etc) think about the foot traffic the room or area usually receives. For example, bedrooms are typically light traffic, living rooms usually medium, and hallways and kitchens would be considered heavy foot traffic areas.

Then choose the features and benefits you want most - like cushioning, durability or insulation.

Finally, from your shortlist of suitable underlays, decide which is closest to what you need.

In the brochure

Our products are arranged by type of floor covering and the recommended traffic level.

The main features and benefits will be highlighted in the six-square panel next to each product. This will help you make the best selection that meets your needs.

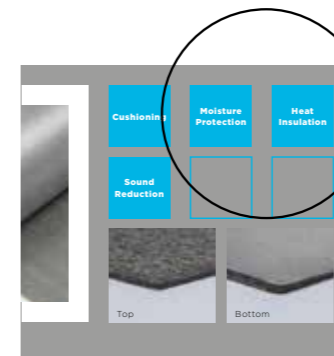

Looks for the features to help you make the right choice for your needs.



Simply Better



At the heart of any complete flooring solution is the underlay. We should know - we sell millions of square metres every year! In this section you will find all you need to know about our underlay options for wood and laminate floors.

Traffilay Group

Light Traffic

| | Cushioning | Level Floors | Hard Wearing | Moisture Protection | Compression Recovery | Heat Insulation | Sound Reduction | Underfloor Heating | Commercial Use | Page No |
|----------------|------------|--------------|--------------|---------------------|----------------------|-----------------|-----------------|--------------------|----------------|---------|
| UniBase Bronze | ■ | | | | | | ■ | ■ | | 15 |
| UniBase Silver | ■ | | | ■ | | ■ | | | | 15 |
| UniBase Gold | ■ | | | ■ | | ■ | | | | 15 |
| Silver Lux | ■ | | | ■ | | | | | | 17 |

Medium Traffic

| | | | | | | | | | | |
|-------------------|---|---|---|---|--|---|---|---|--|----|
| Barrier | ■ | | | ■ | | | | | | 19 |
| Barrier Plus | ■ | | | ■ | | | | | | 19 |
| ProTech | ■ | | | ■ | | ■ | ■ | | | 21 |
| FibreBoard | | ■ | | | | ■ | ■ | | | 23 |
| TechniBoard | | ■ | | | | ■ | ■ | | | 23 |
| QuickTherm | | | ■ | | | | | ■ | | 25 |
| QuickTherm Vapour | | | | ■ | | | | ■ | | 25 |

Heavy Traffic

| | | | | | | | | | | |
|-------------------------|---|--|---|---|---|--|---|---|---|----|
| TimberTech Elite | | | ■ | ■ | ■ | | ■ | ■ | | 27 |
| TimberTech Elite Plus | | | ■ | ■ | ■ | | ■ | ■ | | 27 |
| TimberTech Neo | | | ■ | ■ | | | | ■ | | 29 |
| TimberTech Neo Acoustic | | | ■ | ■ | | | | | | 29 |
| TimberTech Gold | ■ | | | ■ | | | ■ | ■ | ■ | 31 |



WOODERIAS
Specialists

Light
Traffic



100% recyclable PE foam
wood underlays for light traffic
offering terrific value.

Suitable for use with laminate and engineered wood flooring (floating floor installation).

Longer-lasting flooring

UniBase gives your floor covering the perfect level of support to protect it from excess wear and even high impact damage - all of which helps your floor look good for longer!

Lightening the load

The ultra lightweight polyethylene foam material makes UniBase so easy to lift and manoeuvre... you won't believe just how much time and effort that can save you on every installation.

Protects against damp

Don't worry about moisture rising up from the sub-floor - UniBase Silver and UniBase Gold have the added benefit of a metallised vapour barrier that overlaps and protects your floor covering and keeps your room dry as a bone.

Kinder to the environment

100% recyclable closed cell polyethylene foam means that when you use UniBase, you're being kinder to the environment in the long run.



Available in

| Code | Size | Thickness | Pallet QTY |
|------------|--------------------------------|-----------|------------|
| QAU-UBB-02 | 1m x 15m (15m ²) | 2mm | 70 |
| QAU-UBB-03 | 1m x 15m (15m ²) | 3mm | 50 |
| QAU-UBB-05 | 1m x 120m (120m ²) | 2mm | 8 |
| AWC15 | 1m x 15m (15m ²) | 2.5mm | 50 |

| | | |
|------------|-----------------|--------------------|
| Cushioning | Sound Reduction | Underfloor Heating |
| | | |
| | | |
| Top | Bottom | |



Available in

| Code | Size | Thickness | Pallet QTY |
|------------|------------------------------|-----------|------------|
| QAU-UBS-02 | 1m x 15m (15m ²) | 2mm | 70 |

| | | |
|------------|---------------------|-----------------|
| Cushioning | Moisture Protection | Heat Insulation |
| | | |
| | | |
| Top | Bottom | |



Available in

| Code | Size | Thickness | Pallet QTY |
|------------|------------------------------|-----------------------------|------------|
| QAU-UBG-01 | 1m x 10m (10m ²) | 3mm + Overlap and s/a strip | 80 |

| | | |
|------------|---------------------|-----------------|
| Cushioning | Moisture Protection | Heat Insulation |
| | | |
| | | |
| Top | Bottom | |

Wooderlay's Underlays

Light Traffic



Great value 100% recyclable PE foam wood underlay with **moisture protection overlap**.

Protects against moisture

SilverLux gives reliable protection against moisture rising from the sub-floor, keeping your floor dry.

Faster and cleaner fitting

There's no wasting time with SilverLux - it's not only lightweight to lift and move around, but really easy to cut and install so you can get on with the job.

SilverLux gives you less clearing up to do afterwards, as it's dust free and so cleaner and easier to install.

Made with 100% recyclable polyethylene foam.



Available in

| Code | Size | Thickness | Pallet QTY |
|------|------------------------------|---------------|------------|
| SL15 | 1m x 15m (15m ²) | 3mm + Overlap | 50 |

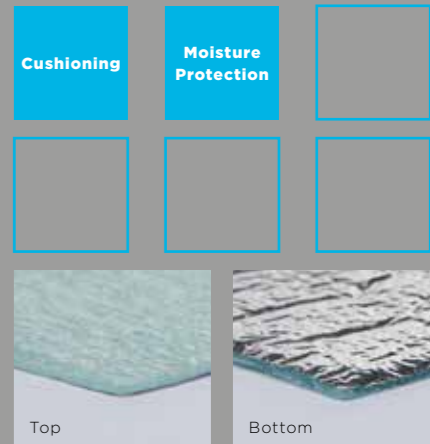

WOODERLAS
Underlays

QA **Barrier & Barrier Plus**
Underlay

Lightweight PE foam
wood underlay for medium traffic
with vapour barrier.

Suitable for use with laminate and engineered wood flooring (floating floor installation).

Protects against damp

Barrier has a clear printed vapour barrier on one side, which effectively and economically stops moisture rising from the subfloor to keep your floor dry.

Barrier Plus has a vapour barrier on both sides and a double overlap, so you're even better protected against rising moisture to keep your floor bone dry.

Support against impact shock

Barrier and **Barrier Plus** give your floor covering the perfect level of support, guarding against excess wear and even high impact damage. It feels good under your feet, too!

Light fantastic

While they're not lightweight in performance, **Barrier** and **Barrier Plus** certainly are easier and safer to lift and handle compared with many underlays - thanks to their ultra-lightweight PE foam making them a breeze to lift and move around... saving time and effort during installation.

The advanced moisture barrier gives this underlay even better resistance to fungi, mould and bacteria and dust-free installation means it is cleaner and easier to work with.

The 100% recyclable polyethylene foam makes this underlay very eco-friendly and kinder to the environment.

Don't forget our **Barrier Jointing Tape** that can be used with **Barrier** wood underlays for added joint seal protection, extra strength and stability, see page 98.

QA **Barrier**
Underlay



Available in

| Code | Size | Thickness | Pallet QTY |
|------------|------------------------------|-----------|------------|
| QAU-BAR-01 | 1m x 15m (15m ²) | 3mm | 50 |

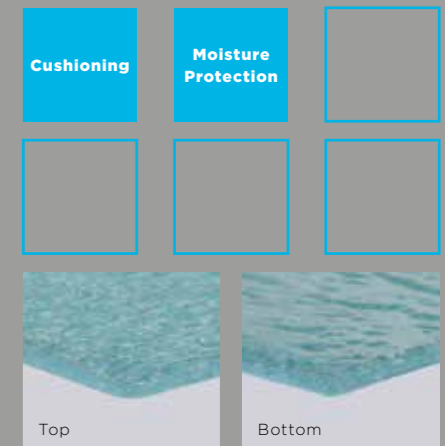

QA **Barrier Plus**
Underlay



Available in

| Code | Size | Thickness | Pallet QTY |
|------------|------------------------------|---------------|------------|
| QAU-BAR-02 | 1m x 15m (15m ²) | 3mm + Overlap | 50 |

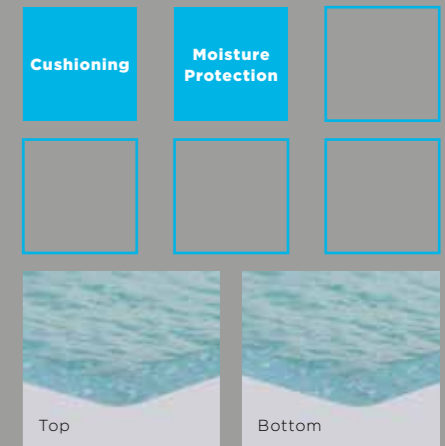

Medium
Traffic



Wooderlay's Underlays

Medium Traffic



Dense PE foam featuring **ultimate damp protection.**

Ultimate protection against moisture

Don't worry about moisture rising up from the subfloor - ProTech is laminated with a full 1000-gauge damp-proof membrane (300 above the industry standard), plus a joint sealing system to keep your room dry as a bone.

Shhh! Underlay at work

Sound insulation... no need to worry about noise levels. ProTech has the added benefit of providing up to 22dB sound reduction.

Lightening the load

The lightweight polyethylene material means ProTech's not only a breeze to lift and move around, but also quick and easy to cut and install -saving time and effort during installation.



Available in

| Code | Size | Thickness | Pallet QTY |
|------------|------------------------------|-----------------------------|------------|
| QAU-PRT-01 | 1m x 10m (10m ²) | 3mm + Overlap and s/a strip | 50 |

| | | |
|-----------------|---------------------|-----------------|
| Cushioning | Moisture Protection | Heat Insulation |
| Sound Reduction | | |
| | | |
| Top | | Bottom |



WOODS
WORLDWIDE



FineFloor TechniBoard & FineFloor FibreBoard Underlay

Lightweight panels to **eliminate uneven subfloors** and improve insulation.

Suitable for use with laminate and engineered wood flooring (floating floor installation).

FineFloor Fibreboard is made from natural wood fibre, offering eco-friendly and stable support for your floor. Not only is the material completely natural and 100% recyclable, Fibreboard is really easy to line up, fit and cut saving you time during installation.

FineFloor TechniBoard is made from clever XPS material, providing a lightweight yet durable solution for uneven subfloors. The modern polystyrene material is easy to lift and move around, helping to get the job done quickly.

Being dust and fibre free means TechniBoard is cleaner to install and helps prevent allergy problems.

Keep out the cold

With exceptional insulation properties, the FineFloor range is perfect for use on ultra-cold subfloors. So, in a basement for example, it'll make your room feel so much cosier and usable.

Quietly does it

Both Fibreboard and TechniBoard have high impact sound reduction, deadening any loud noise to make the whole room quieter and more peaceful.

Medium Traffic



FineFloor TechniBoard Underlay

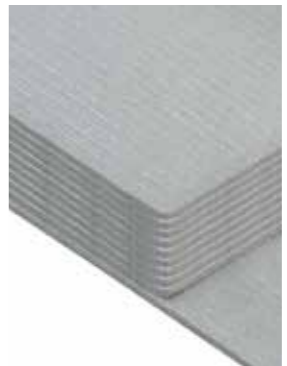

Available in

| Code | Size | Thickness | Pallet QTY |
|------------|--|-----------|------------|
| QAU-FFT-01 | 10 panels 1200mm x 500mm (6m ²)/pack | 5mm | 72 |
| QAU-FFT-02 | 21 panels 590mm x 790mm (9.79m ²)/pack | 5mm | 46 |

Level Floors Heat Insulation Sound Reduction

Top Bottom



FineFloor FibreBoard Underlay



Available in

| Code | Size | Thickness | Pallet QTY |
|------------|---|-----------|------------|
| QAU-FFF-01 | 22 panels 590mm x 850mm x (11.03m ²)/pack | 4mm | 24 |
| QAU-FFF-02 | 20 panels 590mm x 850mm (10.03m ²)/pack | 5mm | 22 |
| QAU-FFF-03 | 14 panels 590mm x 850mm (7.02m ²)/pack | 5mm | 32 |
| QAU-FFF-04 | 17 panels 590mm x 850mm (8.59m ²)/pack | 7mm | 18 |

Level Floors Heat Insulation Sound Reduction

Top Bottom



Underlays

Medium Traffic



QuickTherm & QuickTherm Vapour Underlay

Perforated PE foam underlay specially designed for **underfloor heating**.

Suitable for use with laminate and engineered wood flooring (floating floor installation).

QuickTherm is a red PE foam underlay with innovative perforations which allow optimum transfer of heat from an underfloor heating system to the room.

QuickTherm Vapour is orange in colour and has the additional benefit of a built-in vapour barrier with overlap, to stop moisture rising up from the subfloor.

The underfloor heating underlay

Along with the unique perforated design, QuickTherm and QuickTherm Vapour have extremely low tog ratings which mean your underfloor heating system can work more efficiently which helps with your energy consumption (QuickTherm 0.35 Tog / QuickTherm Vapour 0.303 Tog).

Lifelong supporter

The very dense closed-cell polyethylene material can take the weight of heavy loads long-term, supporting and protecting your floor to keep it in good shape for a longer life

Easy installation

QuickTherm and QuickTherm Vapour are strong on performance but light in weight making it easy and convenient to transport during installation; and being 100% recyclable and dust-free means there is less clean up to do afterwards!



QuickTherm Underlay



Available in

| Code | Size | Thickness | Pallet QTY |
|------------|------------------------------|-----------|------------|
| QAU-QTH-01 | 1m x 10m (10m ²) | 1.8mm | 100 |

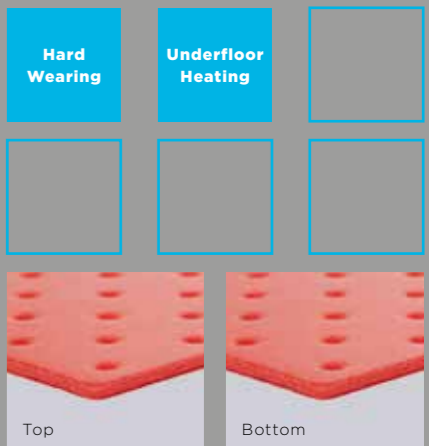

QuickTherm Vapour Underlay



Available in

| Code | Size | Thickness | Pallet QTY |
|------------|------------------------------|---------------|------------|
| QAU-QTH-02 | 1m x 10m (10m ²) | 2mm + Overlap | 100 |

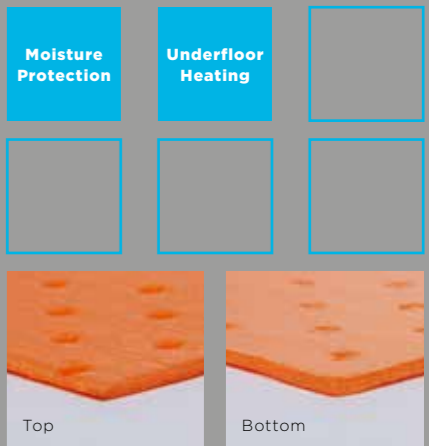

WOODERLAYS
Underlays

QA TimberTech Elite & Elite Plus Underlay

Wood underlays that deliver a new level of **noise reduction** and comfort. Made from PU and mineral components.

Suitable for use with laminate, engineered and solid wood flooring (floating floor installation).

Shhh! Underlay at work

TimberTech Elite Plus reduces walking noise by up to 32% and impact sound by up to 21dB, cutting down noise level and making the room a more comfortable place to be.

Ideal for underfloor heating

With a very low tog value of 0.1, TimberTech Elite and Elite Plus are the perfect choice if you have underfloor heating, letting it heat the floor more efficiently.

Provides strength & stability

The high density and compressive strength fully support the floor and prevent movement, keeping it in good shape for a longer life.

Protects against moisture

A silver vapour barrier gives superior protection against moisture rising from the sub-floor, keeping your floor dry.

Heavy Traffic

QA TimberTech Elite Underlay



Available in

| Code | Size | Thickness | Pallet QTY |
|------------|------------------------------|-----------|------------|
| QAU-TTE-01 | 1m x 10m (10m ²) | 2mm | 56 |

| | | |
|-----------------|---------------------|----------------------|
| Hard Wearing | Moisture Protection | Compression Recovery |
| Sound Reduction | Underfloor Heating | |
| | | |
| Top | Bottom | |

QA TimberTech Elite Plus Underlay



Available in

| Code | Size | Thickness | Pallet QTY |
|------------|------------------------------|-----------|------------|
| QAU-TTE-02 | 1m x 10m (10m ²) | 3mm | 38 |

| | | |
|-----------------|---------------------|----------------------|
| Hard Wearing | Moisture Protection | Compression Recovery |
| Sound Reduction | Underfloor Heating | |
| | | |
| Top | Bottom | |

WOODERIAS
Underlays



TimberTech Neo & TimberTech Neo Acoustic Underlay

Heavyweight natural crumb rubber underlay with **outstanding noise reduction.**

Shhh! Underlay at work

TimberTech Neo is a 3mm thick, rubber crumb underlay providing an impressive 23dB sound reduction.

TimberTech Neo Acoustic is a 5mm thick rubber crumb underlay making it a winner for heavy weight jobs. In addition, this superb underlay has a felt backing which provides stability when cutting and installing and an even more impressive 26dB sound reduction.

Dry as a bone

The silver vapour barrier on TimberTech Neo and the gold vapour barrier on TimberTech Neo Acoustic prevent moisture rising from the sub-floor - protecting your floor covering against damp.

Old tyre, new life

TimberTech is made with rubber from recycled tyres, which means old tyres don't go into landfill - so it's better for the planet.

Use QA Vapour Tape on joints for added moisture protection. See page 98.

Heavy Traffic



TimberTech Neo Underlay



Available in

| Code | Size | Thickness | Pallet QTY |
|------------|------------------------------|-----------|------------|
| QAU-TNE-01 | 1m x 10m (10m ²) | 3mm | 40 |

| | | |
|--------------------|---------------------|-----------------|
| Hard Wearing | Moisture Protection | Sound Reduction |
| Underfloor Heating | | |
| Top | | Bottom |



TimberTech Neo Acoustic Underlay



Available in

| Code | Size | Thickness | Pallet QTY |
|------------|----------------------------|-----------|------------|
| QAU-TNA-01 | 1m x 8m (8m ²) | 5mm | 20 |

| | | |
|--------------|---------------------|-----------------|
| Hard Wearing | Moisture Protection | Sound Reduction |
| | | |
| Top | | Bottom |



Wooderlay's Underlays

Heavy Traffic



Premium ultra-thick natural rubber underlay with **vapour barrier**

Stability you can rely on

TimberTech Gold's heavy mass stability is exceptional, preventing movement in your flooring to keep it looking good longer.

Quiet please...

With its ultra-thick laminated material, TimberTech Gold has an outstanding acoustic performance of 23dB to make any room more comfortable.

Protects against damp

A gold vapour barrier gives superior protection against moisture rising from the sub-floor - so your room stays dry.



Available in

| Code | Size | Thickness | Pallet QTY |
|------------|------------------------------|-----------|------------|
| QAU-TTG-01 | 1m x 10m (10m ²) | 3.3mm | 30 |

| | | |
|-----------------|---------------------|----------------|
| Cushioning | Moisture Protection | Commercial Use |
| Sound Reduction | Underfloor Heating | |
| | | |
| Top | Bottom | |

Wood Underlays



Wood Underlays Light Traffic

| Product | Density kg/m ³ | Impact Sound Reduction dB | Thermal Resistance Tog Value | Compressive Strength kPa | Reaction to fire |
|-----------------------|------------------------------|------------------------------|---------------------------------|-----------------------------|------------------|
| UniBase Bronze | 20 ± 10% | -19 (2mm) -20 (3mm) | 0.44 (2mm) 0.67 (3mm) | | |
| UniBase Silver | 20 ± 10% | -19 (2mm) | 0.44 | | |
| UniBase Gold | 20 ± 10% | -20 | 0.67 | | |
| Silver Lux | 20 ± 10% | -20 | 0.67 | | |

Wood Underlays Medium Traffic

| Product | Density kg/m ³ | Impact Sound Reduction dB | Thermal Resistance Tog Value | Compressive Strength kPa | Reaction to fire |
|--------------------------|------------------------------|------------------------------|---------------------------------|-----------------------------|------------------|
| Barrier | 20 ± 10% | -20 | 0.67 | | |
| Barrier Plus | 20 ± 10% | -20 | 0.67 | | |
| ProTech | 25 ± 10% | 22 | 0.67 | | |
| FibreBoard 4mm | 260 ± 10% | 18 | 0.8 | >150 | |
| FibreBoard 5mm | 260 ± 10% | 18 | 1 | >150 | |
| FibreBoard 7mm | 260 ± 10% | 18 | 1.4 | >150 | |
| TechniBoard | 40 ± 10% | -19 | 2.15 | | |
| QuickTherm | 100 ± 10% | -19 | 0.35 | | |
| QuickTherm Vapour | 60 ± 10% | -19 | 0.303 | | |

Wood Underlays Heavy Traffic

| Product | Density kg/m ³ | Impact Sound Reduction dB | Thermal Resistance Tog Value | Compressive Strength kPa | Reaction to fire |
|--------------------------------|------------------------------|------------------------------|---------------------------------|-----------------------------|-----------------------------|
| TimberTech Elite | 850 ± 10% | 20 ± 2 | 0.1 | up to 240 | Bfl-s1 |
| TimberTech Elite Plus | 850 ± 10% | 21 ± 2 | 0.1 | up to 120 | Bfl-s1 |
| Timbertech Neo | 400 ± 10% | 22 | 0.72 | | Pass (Low radius of effect) |
| Timbertech Neo Acoustic | 400 ± 10% | 26 | 0.73 | | Pass (Low radius of effect) |
| TimberTech Gold | 950 ± 10% | -23 | 0.53 | | Pass (Low radius of effect) |





Simply Better

Carpet Underlays

It's easy to think all carpet underlays are the same. After all, they spend most of their life hidden away. But you'd be surprised how much difference choosing the right underlay can make to any room. Mainly it is about comfort, but it can also be about keeping flooring looking good for longer.

Traffilay Group

Light Traffic

| | Cushioning | Level Floors | Hard Wearing | Moisture Protection | Compression Recovery | Heat Insulation | Sound Reduction | Underfloor Heating | Commercial Use | Page No |
|--------------------|------------|--------------|--------------|---------------------|----------------------|-----------------|-----------------|--------------------|----------------|---------|
| FloorSure Silver | ■ | | | | ■ | | | | | 37 |
| FloorSure Gold | ■ | | | | ■ | | | | | 37 |
| FloorSure Platinum | ■ | | | | ■ | | | | | 37 |

Medium Traffic

| | | | | | | | | | | |
|------------------------|---|--|--|--|---|--|--|--|--|----|
| SpringBack Silver | ■ | | | | ■ | | | | | 39 |
| SpringBack Gold | ■ | | | | ■ | | | | | 39 |
| Pure High Density 8mm | ■ | | | | ■ | | | | | 43 |
| Pure High Density 10mm | ■ | | | | ■ | | | | | 43 |

Heavy Traffic

| | | | | | | | | | | |
|------------------------------|---|--|---|--|---|---|---|---|---|----|
| Pure Super High Density 9mm | ■ | | | | ■ | ■ | | | | 44 |
| Pure Super High Density 11mm | ■ | | | | ■ | ■ | | | | 44 |
| Pure Ultra High Density 9mm | | | ■ | | ■ | ■ | | | | 45 |
| Pure Ultra High Density 11mm | | | ■ | | ■ | ■ | | | | 45 |
| PowerWalk Silver | | | ■ | | ■ | | | | | 47 |
| PowerWalk Gold | | | ■ | | ■ | ■ | ■ | | | 47 |
| CombiFelt Acoustic | | | ■ | | | | ■ | | ■ | 49 |
| HeatWave | ■ | | | | | | | ■ | | 51 |
| ExtraStep | | | ■ | | | | ■ | ■ | ■ | 52 |
| Powerstep | | | ■ | | ■ | | | | | 53 |
| Breathe | | | ■ | | ■ | | ■ | | | 55 |



Carpet Underlays

Light Traffic



FloorSure Silver, Gold & Platinum Underlay

Resilient PU foam with a **truly luxurious feel.**

Feels great to feet

FloorSure is made from a polyurethane foam that's light in weight but gives your feet a real treat - warm and comfortable, coupled with a softness that feels simply gorgeous!

Light fantastic

FloorSure is certainly much easier and safer to lift and handle compared with sponge rubber and felt underlays - thanks to its lightweight PU foam.

FloorSure also offers very good thermal insulation, to help your whole room feel warmer and more comfortable.

It's not only light and easy to manoeuvre, but also quick and easy to cut and install - saving time on installation.

With 100% recyclable polyurethane foam, this eco-friendly underlay improves the environment in more ways than one.



FloorSure Silver Underlay



Available in

| Code | Size | Thickness | Pallet QTY |
|------------|------------------------------------|-----------|------------|
| QAU-FSS-01 | 1.37m x 11m (15.07m ²) | 8mm | 28 |

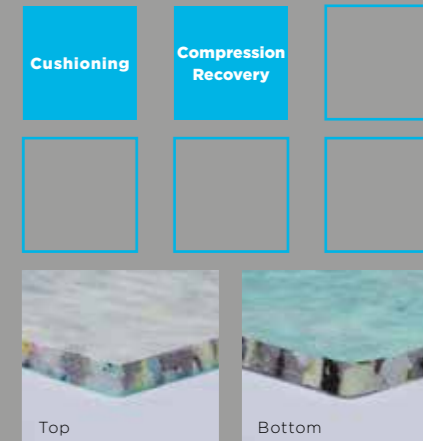

Top Bottom



FloorSure Gold Underlay



Available in

| Code | Size | Thickness | Pallet QTY |
|------------|------------------------------------|-----------|------------|
| QAU-FSG-01 | 1.37m x 11m (15.07m ²) | 10mm | 21 |

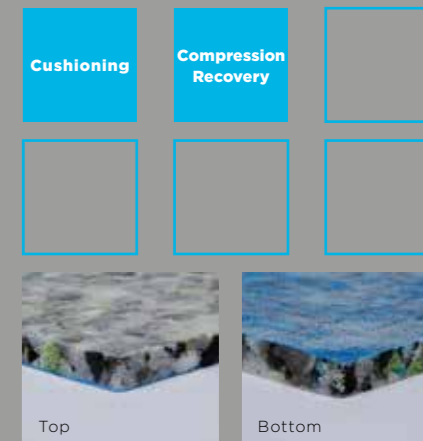

Top Bottom



FloorSure Platinum Underlay



Available in

| Code | Size | Thickness | Pallet QTY |
|------------|------------------------------------|-----------|------------|
| QAU-FSP-01 | 1.37m x 11m (15.07m ²) | 12mm | 18 |

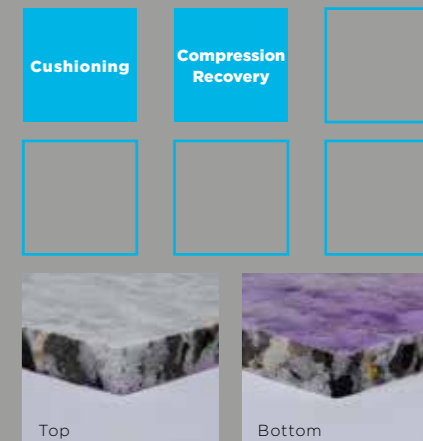

Top Bottom



Carpet Underlays

Medium Traffic

QA SpringBack Silver & Gold Underlay

A premium PU foam underlay with excellent bounce back ability.

Pure underfoot luxury
SpringBack top-grade polyurethane foam has an unbelievable softness to give unbeatable underfoot comfort.

SpringBack by name...and nature
It's all in the name...SpringBack really performs under pressure, retaining its ability to spring back much better than a typical sponge rubber product. Your carpet will look good for so much longer!

Designed for durability
SpringBack is extremely hardwearing and won't dry out, crumble or react to everyday household cleaners. In fact, it's guaranteed for the lifetime of the carpet!

With 100% recyclable polyurethane foam, this eco-friendly underlay improves the environment in more ways than one.

QA SpringBack Silver Underlay



Available in

| Code | Size | Thickness | Pallet QTY |
|------------|-----------------------------------|-----------|------------|
| QAU-SBS-01 | 1.37 x 11m (15.07m ²) | 8mm | 24 |

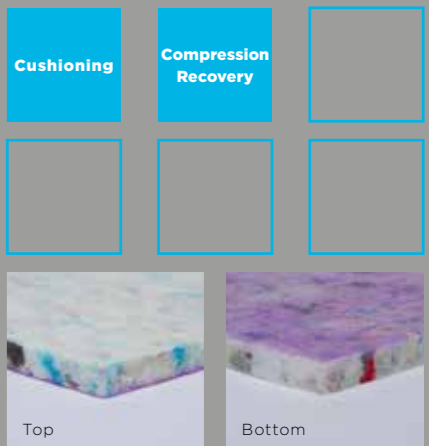

Top



Bottom

QA SpringBack Gold Underlay



Available in

| Code | Size | Thickness | Pallet QTY |
|------------|-----------------------------------|-----------|------------|
| QAU-SBG-01 | 1.37 x 11m (15.07m ²) | 10mm | 21 |

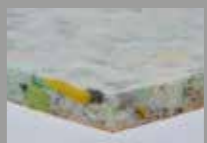
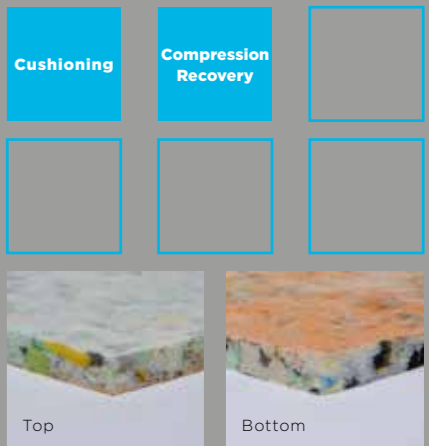

Top



Bottom



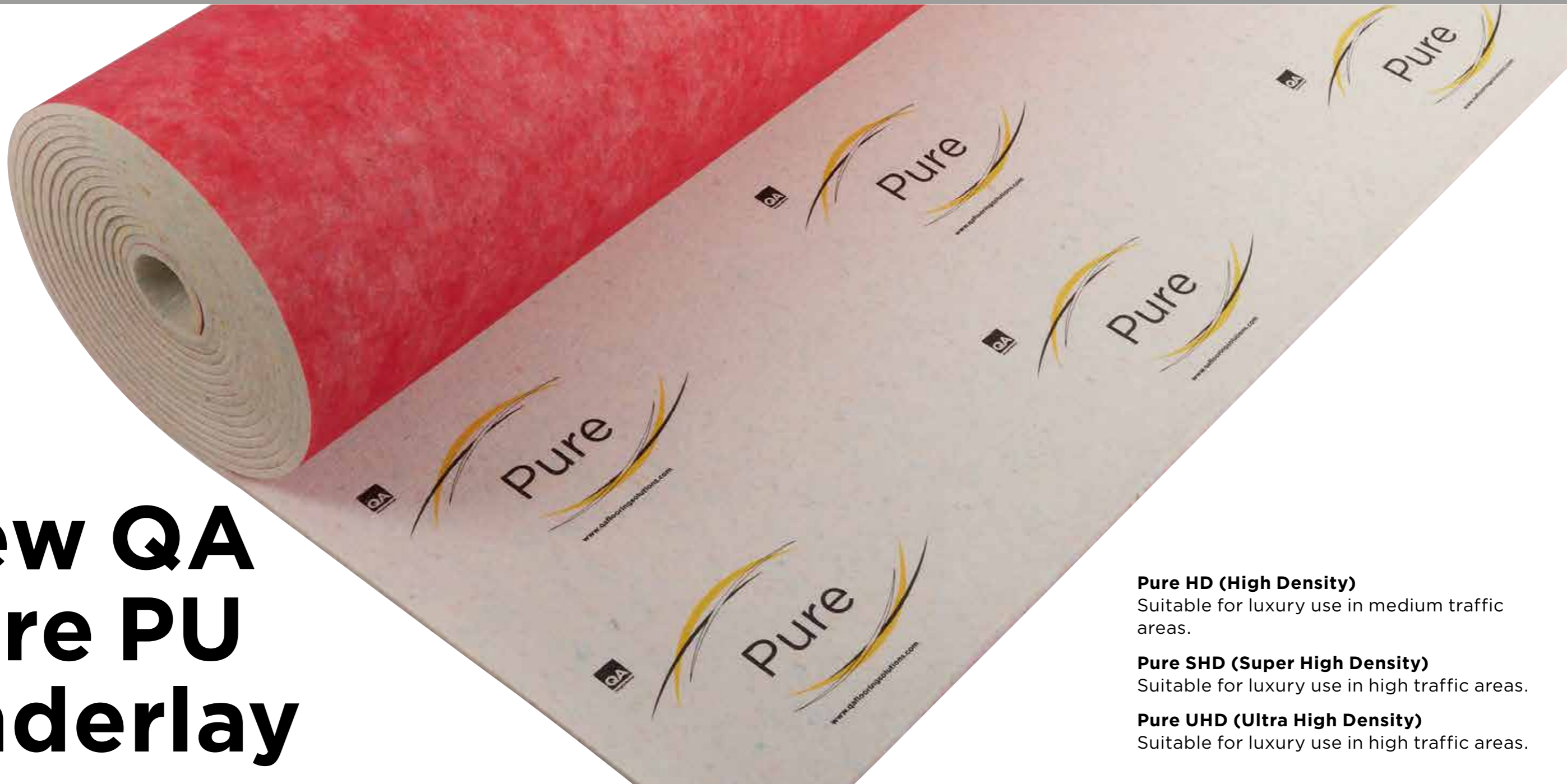

New QA Pure PU Underlay

Pure HD (High Density)

Suitable for luxury use in medium traffic areas.

Pure SHD (Super High Density)

Suitable for luxury use in high traffic areas.

Pure UHD (Ultra High Density)

Suitable for luxury use in high traffic areas.



Carpet Underlays Pure



Introducing a **luxurious collection of PU carpet underlay**, which is as indulgent as it is robust.

Only the purest, highest-grade foam is used in the production of the Pure range, setting a new industry standard in comfort.

The material used is subject to a stringent sorting process which removes imperfections and lower grade dark coloured foam, resulting in an impeccably clean PU material. This gives Pure the most sumptuous feel under the carpet, unsurpassed by other luxury underlays on the market.

- Three different density options available - High Density (HD), Super High Density (SHD) and Ultra High Density (UHD)
- Two thickness options available each for HD, SHD and UHD
- Non-woven backing and printed top layer for improved stability
- Pure branded premium packaging



Suitable for luxury domestic use in medium traffic areas.



Available in

| Code | Size | Thickness | Pallet QTY |
|------------|------------------------------------|-----------|------------|
| QAU-PUR-01 | 1.37m x 11m (15.07m ²) | 8mm | 24 |

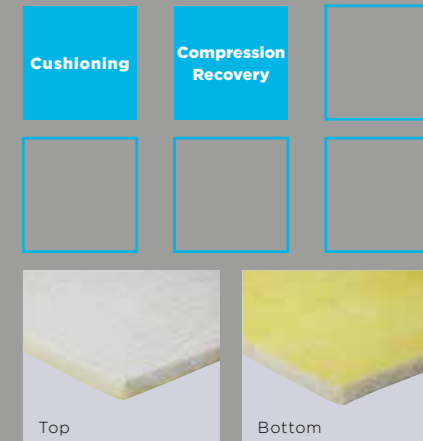

Suitable for luxury domestic use in medium traffic areas.



Available in

| Code | Size | Thickness | Pallet QTY |
|------------|------------------------------------|-----------|------------|
| QAU-PUR-02 | 1.37m x 11m (15.07m ²) | 10mm | 21 |

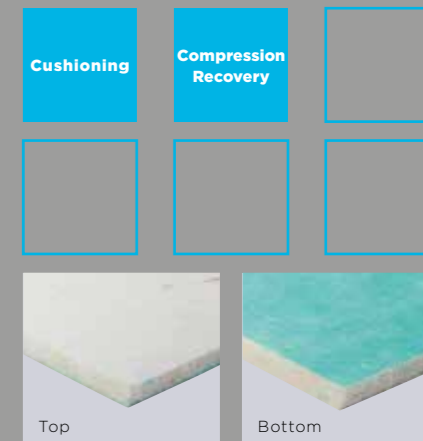

Medium Traffic



QA **Pure SHD 9mm**
Underlay

Suitable for luxury domestic use in heavy traffic areas.



Available in

| Code | Size | Thickness | Pallet QTY |
|------------|------------------------------------|-----------|------------|
| QAU-PUR-03 | 1.37m x 11m (15.07m ²) | 9mm | 21 |



Cushioning

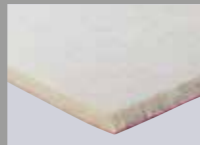

Top

Compression Recovery



Bottom

Heat Insulation



QA **Pure UHD 9mm**
Underlay

Suitable for luxury domestic use in heavy traffic areas.



Available in

| Code | Size | Thickness | Pallet QTY |
|------------|------------------------------------|-----------|------------|
| QAU-PUR-05 | 1.37m x 11m (15.07m ²) | 9mm | 21 |



Compression Recovery



Top

Hard Wearing



Bottom

Heat Insulation



QA **Pure SHD 11mm**
Underlay

Suitable for luxury domestic use in heavy traffic areas.



Available in

| Code | Size | Thickness | Pallet QTY |
|------------|------------------------------------|-----------|------------|
| QAU-PUR-04 | 1.37m x 11m (15.07m ²) | 11mm | 18 |



Cushioning



Top

Compression Recovery



Bottom

Heat Insulation



QA **Pure UHD 11mm**
Underlay

Suitable for luxury domestic use in heavy traffic areas.



Available in

| Code | Size | Thickness | Pallet QTY |
|------------|------------------------------------|-----------|------------|
| QAU-PUR-06 | 1.37m x 11m (15.07m ²) | 11mm | 18 |



Hard Wearing



Top

Compression Recovery



Bottom

Heat Insulation



Heavy Traffic

Heavy Traffic



Carpet Underlays

Heavy Traffic

QA PowerWalk Silver & Gold Underlay

High Density PU foam underlay perfect **for heavy duty domestic use.**

High density and hardwearing

The polyurethane foam in PowerWalk is extra high density (130kg/m³) so it's extremely hardwearing, keeping your carpet looking good for longer.

Performance under pressure

Under pressure, this is an underlay that really performs - with excellent compression recovery - to help your carpet keep that 'just-fitted' look.

Keeps flooring in its place

PowerWalk Silver has excellent stability to stop movement in your carpet, greatly reducing wear and tear.

Excellent thermal insulation

PowerWalk Silver has a 2.3 tog rating with PowerWalk Gold delivering 2.92 tog performance; which means your whole room feels warmer and more comfortable.

Sound Reduction

The sheer density of PowerWalk helps give it first-rate impact and sound insulation (Silver 38dB / Gold 44dB), making your room quieter.

QA PowerWalk Silver Underlay



Available in

| Code | Size | Thickness | Pallet QTY |
|------------|------------------------------------|-----------|------------|
| QAU-PWS-01 | 1.37m x 11m (15.07m ²) | 9mm | 20 |



QA PowerWalk Gold Underlay



Available in

| Code | Size | Thickness | Pallet QTY |
|------------|------------------------------------|-----------|------------|
| QAU-PWG-01 | 1.37m x 11m (15.07m ²) | 11mm | 20 |

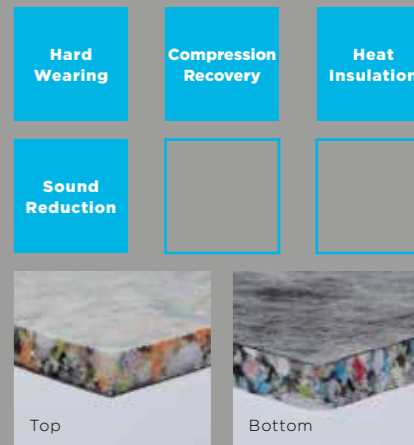

Carpet Underlays

Heavy Traffic



CombiFelt Acoustic Underlay

Extra-tough felt and rubber combination, perfect **for prestige carpets**.

A touch more luxurious

Giving a firm but truly plush feel under your feet, this is an ideal choice for luxury settings and is widely used under Axminster and quality twist carpets.

Built to last

This underlay is designed for fantastic durability. It won't crumble over time and takes even the heaviest use in its stride - it exceeds BS5808 (Heavy Contract Use)!

Shhh! Underlay at work

CombiFelt Acoustic has unbelievable impact sound insulation... so not only does it make your carpet feel softer and more luxurious you'll notice a real difference in noise levels.



CombiFelt Acoustic Underlay



Available in

| Code | Size | Thickness | Pallet QTY |
|------------|----------------------------------|-----------|------------|
| QAU-CFA-01 | 1.37m x 7.3m (10m ²) | 10mm | 15 |

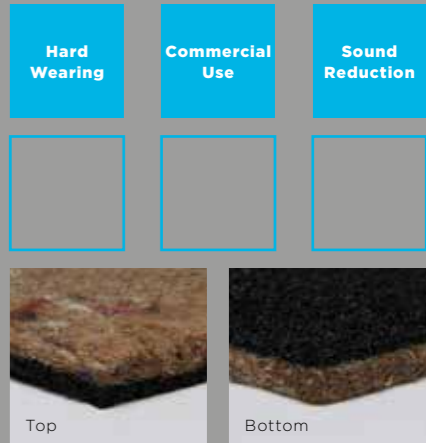

Carpet Underlays

Heavy Traffic



A super soft PU foam underlay which is **flame retardant**.

Fire safety comes first

HeatWave is designed to be safer if a fire breaks out in the home, thanks to its flame retardant properties...so there's no need to worry about hidden dangers under your floor if the worst should happen.

That soft feeling...

HeatWave is made from very pure polyurethane foam, so is incredibly soft and gives unbeatable underfoot comfort...sitting on your carpet will feel like sitting on your sofa!

Heatwave under the floor

HeatWave has a tog value of only 1.2, which allows underfloor heating to work away at keeping the room nice and warm.



Available in

| Code | Size | Thickness | Pallet QTY |
|------------|------------------------------------|-----------|------------|
| QAU-HWA-01 | 1.37m x 11m (15.07m ²) | 8mm | 32 |

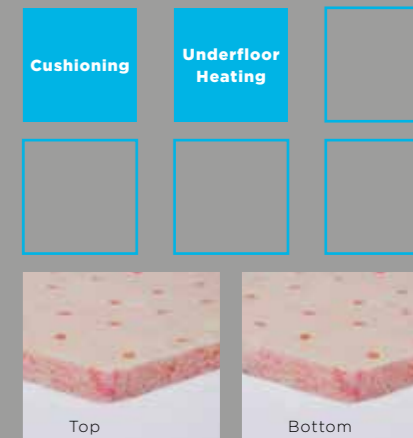

QA **ExtraStep**
Underlay

Extra high-density (180kg) 6mm PU underlay with impressive 33dB sound reduction; suitable for underfloor heating.

Suitable for heavy domestic, commercial and marine jobs and double stick installation – a common method used for fast installation that helps reduce rucking in high traffic areas.

Available in

| Code | Size | Thickness | Pallet QTY |
|------------|------------------------------------|-----------|------------|
| QAU-WFF-01 | 1.37m x 11m (15.07m ²) | 6mm | 34 |



| | | |
|-----------------|----------------|--------------------|
| Hard Wearing | Commercial Use | Underfloor Heating |
| Sound Reduction | | |
| Top | Bottom | |

QA **PowerStep**
Underlay

PowerStep is an extra high-density PU underlay suitable for a variety of installation types.

It is a 9mm thick, 145kg density PU underlay, suitable for heavy traffic domestic installations.

Available in

| Code | Size | Thickness | Pallet QTY |
|------|------------------------------------|-----------|------------|
| CPS4 | 1.37m x 11m (15.07m ²) | 9mm | 24 |



| | | |
|--------------|----------------------|--|
| Hard Wearing | Compression Recovery | |
| | | |
| Top | Bottom | |

Heavy Traffic **Carpet Underlays**



Carpet Underlays

Heavy Traffic

QA

Breathe

Next Generation Natural Underlay

A completely natural alternative to PU made from wood fibre!

PureHome
Next Generation Natural Underlay

QA **Breathe**
Underlay



Available in

| Code | Size | Thickness | Pallet QTY |
|------------|-------------------------------------|-----------|------------|
| QAU-BRE-02 | 1.1m x 13.7m (15.07m ²) | 10mm | 15 |

| Hard Wearing | Compression Recovery | Sound Reduction |
|--------------|----------------------|-----------------|
| | | |
| | | |
| Top | | Bottom |

Breathe

Breathe is an exciting new innovation in underlay, designed to offer underfoot luxury and improve your air quality to look after your health. Its natural wood fibres filter out dust, even the smallest particles, for a fresher, cleaner, more comfortable home.

- Supremely comfortable to walk on, Breathe is ideal for every room in the house. It's strong and stable, yet lightweight, making it easy to cut and install; and being fully biodegradable, Breathe is better for the environment, even at the end of its life!
- Breathe is an extraordinary innovation in underlay: made from wood fibres, it has the ability to improve the air quality in your home.
- As well as having incredible filtering properties, this material is extremely consistent - none of the hard lumps and bumps associated with some underlays. In fact the quality is outstanding, and Breathe fully meets every BS5808 performance standard.

The alternative to PU underlay.



Why it's a breath of fresh air for floors



Easy to cut and install

Breathe is easier to work with than standard PU underlay, offering cleaner cuts and no snagging.



Faster installation time = more turnaround

Our tests have shown that a fitter can install Breathe up to 3x faster than a PU underlay.



100% Natural Product

There are no lumpy bits in Breathe underlay which saves fitters having to patch any uncomfortable areas.





COMFORT UNDERFOOT STARTS WITH QA - STEP RIGHT THIS WAY!

QA PU underlays are made from high-density foam and have a strong non-woven fleece layer on both sides. They are tested and recommended for luxury use.

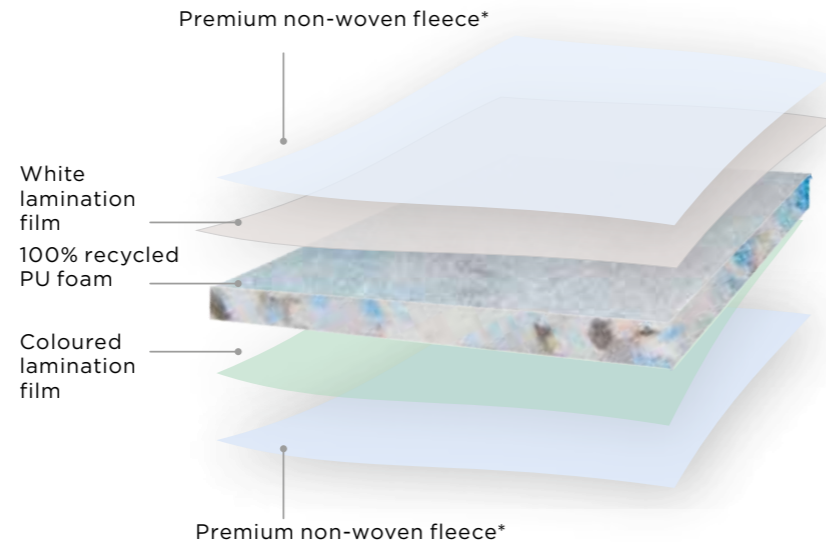

*Premium non-woven fleece gives a soft feel and makes the underlay very stable (preventing stretching and rucking under the carpet).

Carpet Underlays Light Traffic

| Product | Density | Thickness | Impact Sound Reduction | Thermal Resistance | Flammability |
|--------------------|-------------------|-----------|------------------------|--------------------|------------------------------|
| | kg/m ³ | mm | dB | Tog Value | |
| FloorSure Silver | 75 ± 5% | 8 ± 5% | 32 | 2.18 | Pass - High Radius of effect |
| FloorSure Gold | 75 ± 5% | 10 ± 5% | 40 | 2.6 | Pass - High Radius of effect |
| FloorSure Platinum | 75 ± 5% | 12 ± 5% | 44 | 2.95 | Pass - High Radius of effect |

Carpet Underlays Medium Traffic

| Product | Density | Thickness | Impact Sound Reduction | Thermal Resistance | Flammability |
|-------------------|-------------------|--------------------------------|---------------------------------------|---------------------------|--------------------------------|
| | kg/m ³ | mm | dB | Tog Value | |
| SpringBack Silver | 85 ± 5% | 8 ± 5% | 34 | 2.3 | Pass - Medium Radius of effect |
| SpringBack Gold | 85 ± 5% | 10 ± 5% | 40 | 2.75 | Pass - Medium Radius of effect |
| Pure High Density | 85 ± 5% | 8 ± 5% (8mm) 10 ± 5% (10mm) | Approx. 34 (8mm) Approx. 40 (10mm) | 2.25 (8mm) 2.79 (10mm) | Pass - Medium Radius of effect |

Carpet Underlays Heavy Traffic

| Product | Density | Thickness | Impact Sound Reduction | Thermal Resistance | Flammability |
|-------------------------|-------------------|--------------------------------|---------------------------------------|---------------------------|--------------------------------|
| | kg/m ³ | mm | dB | Tog Value | |
| Pure Super High Density | 100 ± 5% | 9 ± 5% (9mm) 11 ± 5% (11mm) | Approx. 38 (9mm) Approx. 44 (11mm) | 2.43 (9mm) 3.04 (11mm) | Pass - Medium Radius of effect |
| Pure Ultra High Density | 145 ± 5% | 9 ± 5% (9mm) 11 ± 5% (11mm) | Approx. 38 (9mm) Approx. 44 (11mm) | 2.44 (9mm) 2.81 (11mm) | Pass - Medium Radius of effect |
| PowerWalk Silver | 130 ± 5% | 9 ± 5% | 38 | 2.3 | Pass - Low Radius of effect |
| PowerWalk Gold | 130 ± 5% | 11 ± 5% | 44 | 2.92 | Pass - Low Radius of effect |
| CombiFelt Acoustic | | 10 ± 5% | 34 | | Pass - Low Radius of effect |
| HeatWave | 110 ± 5% | 8 ± 5% | 36 | 1.2 | Pass - Low Radius of effect |
| Extrastep | 180 ± 5% | 6 ± 5% | 33 | 1.77 | Pass - Low Radius of effect |
| Powerstep | 145 ± 5% | 9 ± 5% | 40 | 2.6 | Pass - Low Radius of effect |
| Breathe | 100 ± 5% | 10 ± 5% | | 2.8 | Pass - Low Radius of effect |





Simply Better

Acoustic Solutions

A range of industry leading acoustic materials to help meet or surpass Building Regulations for England, Wales, Scotland and Ireland. We have the expertise to provide you with the correct solution to combat airborne and impact noise.

Traffilay Group Heavy Traffic

| Acoustic Systems | Cushioning | Level Floors | Hard Wearing | Moisture Protection | Compression Recovery | Heat Insulation | Sound Reduction | Underfloor Heating | Commercial Use | Page No |
|--------------------------------|------------|--------------|--------------|---------------------|----------------------|-----------------|-----------------|--------------------|----------------|---------|
| SoundBarrier | | | ■ | | | | ■ | ■ | | 61 |
| Regupol Sonus 3912 | | ■ | ■ | | | | ■ | | ■ | 63 |
| Regupol Sonus 4515 Multi 3mm | | | ■ | | | | ■ | ■ | ■ | 63 |
| Regupol Sonus 4515 Multi 4.5mm | | | ■ | | | | ■ | | ■ | 63 |
| Regupol Sonus 4515 Eco 3mm | | | ■ | | | | ■ | ■ | ■ | 63 |
| Regupol Sonus 4515 Eco 4.5mm | | | ■ | | | | ■ | | ■ | 63 |
| Quiet Cork 2mm | | | ■ | | | | ■ | ■ | ■ | 65 |
| Quiet Cork 5mm | | ■ | ■ | | | | ■ | | ■ | 65 |
| E-Board Timber | | ■ | | | | ■ | ■ | | ■ | 67 |
| E-Board Concrete | | ■ | | | | ■ | ■ | | ■ | 67 |
| E-Board Pro | | ■ | | | | ■ | ■ | | ■ | 67 |





High performance acoustic underlay for **glue down and click LVT Installations.**

Quietly does it

SoundBarrier provides an exceptional 24dB of impact sound reduction - higher than any other LVT underlay available. It also reduces walking noise by 31%, making the room a whole lot quieter.

Built to last

Made from a high-density polypropylene foam, SoundBarrier will easily last the lifetime of the floor, even under the heaviest foot traffic. It creates a stable base which supports the floor for life.

Protects against damp

The unique moisture-guard properties of SoundBarrier stop moisture getting through from the sub-floor, keeping the floor dry.

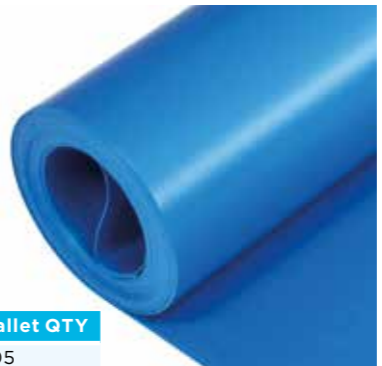

Available in

| Code | Size | Thickness | Pallet QTY |
|------------|------------------------------------|-----------|------------|
| QAU-SBR-02 | 0.89m x 16.85m (15m ²) | 1mm | 105 |

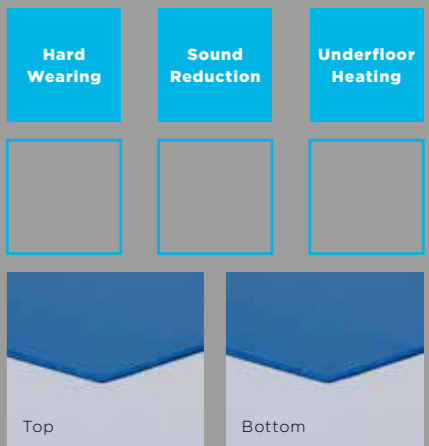

QA Regupol Sonus Underlay

Acoustic system which helps **comply with Part E of Building Regulations.**

Regupol® Sonus 3912 is a tough, resilient acoustic underlay manufactured from PUR Foam and is ideally suited to refurbishment and timber-based constructions to comply with Part E. It can also be used for new build.

Regupol® Sonus 4515 Multi & Eco are multi-purpose acoustic underlay systems which help comply with Part E of Building Regulations for impact sound reduction. They can be used over most types of sub floor and with all types of floor finish.

Performance under pressure

Regupol® Sonus offers long term performance without collapse or “bottoming” out under high point loads and is resistant to ageing and deformation. With high quality and exact material thickness guaranteed, it reduces construction heights.

Comfort under foot

Suitable for use with under floor heating and is also very comfortable under foot.

Fit it fast!

Quick and easy to install. Simply bond to the subfloor beneath the final floor finish.

Manufactured using recycled materials and 100% recyclable.

Consultation with our Technical Support Team is recommended prior to specification.

QA Regupol Sonus 3912 Underlay



Available in

| Code | Size | Thickness | Pallet QTY |
|--------|------------------------------|-----------|------------|
| RP3912 | 1m x 15m (15m ²) | 6mm | 15 |

QA Regupol Sonus Multi Underlay



* Only 3mm suitable for underfloor heating.

Available in

| Code | Size | Thickness | Pallet QTY |
|-----------|------------------------------|-----------|------------|
| RP4515M3 | 1m x 20m (20m ²) | 3mm | 15 |
| RP4515M45 | 1m x 18m (18m ²) | 4.5mm | 15 |

QA Regupol Sonus Eco Underlay



* Only 3mm suitable for underfloor heating.

Available in

| Code | Size | Thickness | Pallet QTY |
|-----------|-----------------------------------|-----------|------------|
| RP4515E3 | 1.15m x 20m (23m ²) | 3mm | 20 |
| RP4515E45 | 1.15m x 12m (13.8m ²) | 4.5mm | 20 |

| Hard Wearing | Sound Reduction | Level Floors |
|----------------|-----------------|---------------------|
| Commercial Use | | |
| | | |
| Top | Bottom | |
| Hard Wearing | Sound Reduction | Underfloor Heating* |
| Commercial Use | | |
| | | |
| Top | Bottom | |
| Hard Wearing | Sound Reduction | Underfloor Heating* |
| Commercial Use | | |
| | | |
| Top | Bottom | |





Quiet Cork is a Recycled Cork & EVA Resilient layer that has been developed to reduce impact noise on both timber and concrete floors, can also be used with carpet and laminate flooring, and helps to achieve Part E of Building Regulations.

Lightweight performance

Cork cells are filled with a mixture of gasses which reduces weight, the composite of Cork is approximately 40% bark and 60% gas which helps keep the weight low.

Environmentally friendly and sustainable

Cork is also a product that can be fully recycled once the product is at the end of its life, all of the cork used in our Quiet Cork acoustic underlays is from recycled cork.

Benefits of cork

- Anti-Static
- Anti-Allergic
- Bug Resistant - Cork contains suberin which is a natural insect repellent
- Air Quality - Naturally antimicrobial and water resistant
- Fire - if cork is burnt, no toxic fumes are emitted
- Thermal Insulator - thin underlays are suitable for underfloor heating
- Carbon Negative - any waste is recycled back into the production line
- Sustainability - Portuguese Cork Oak Trees retain approximately 14 million tonnes of CO2 yearly, no trees are cut or damaged when harvesting



* Only 2mm suitable for underfloor heating.
** Only 5mm suitable to level floors.

Available in

| Code | Size | Thickness | Pallet QTY |
|------------|------------------------------|-----------|------------|
| QAU-CWO-01 | 1m x 10m (10m ²) | 2mm | 35 |
| QAU-CWO-02 | 1m x 10m (10m ²) | 5mm | 12 |



As used under a timber floor.

| | | |
|----------------|-----------------|---------------------|
| Hard Wearing | Sound Reduction | Underfloor Heating* |
| Commercial Use | Level Floors** | |
| | | |
| Top | Bottom | |





E-Board Timber, E-Board Concrete & E-Board Pro Underlay

High performance underlay system for timber and concrete subfloors with **brilliant acoustic performance.**

E-Board Timber is a high-mass yet resilient high-performance acoustic underlay, designed to help reduce both impact and airborne noise that helps meet or surpass Building Regulations Part E Resistance to the Transmission of Sound, primarily for timber sub-floors.

E-Board Concrete is ideal for new, retrofit or renovation projects in offices, homes and hotels. E-Board Concrete helps meet or surpass Building Regulations Part E Resistance to the Transmission of Sound, primarily for concrete sub-floors.

E-Board Pro - High Mass acoustic resilient layer that has been specifically designed to reduce impact and airborne noise primarily on timber floors.

Quiet please...

E-Board with a layer of Class O Acoustic Foam under or sandwiched between an acoustic barrier means excellent impact (53-57dB) and airborne sound (47-54dB) insulation - ideal for new, retrofit or renovation projects in offices, homes and hotels.

Fire safe and sound

Meeting BS476: parts 6 & 7 - the highest level for Class O - the Acoustic Foam is a fully tested for fire resistance - and peace of mind.

Commercial or residential - meet the regs

Whether it's used in commercial or residential installations, you can rely on E-Board to fully comply with Doc E of the Building Regulations.

Ideal under any floor finish - carpet can be fitted directly onto it, but for solid wood, laminate, ceramic, or vinyl we recommend adding 6mm ply or MDF to reduce flex.

With any type of uneven subfloor, the E-Board underlay levels it out to provide a perfect base for any floor covering.

Save time and effort during fitting with lightweight 1.2m x 1m tiles that are easy to lift and simple to cut and install.



E-Board Timber Underlay



Available in

| Code | Size | Thickness | Pallet QTY |
|------------|--------------------------------|-----------|------------|
| QAU-EBT-01 | 1.2m x 1m (1.2m ²) | 12mm | 50 sheets |

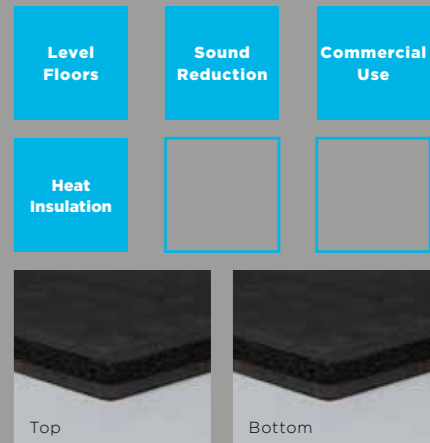

E-Board Concrete Underlay



Available in

| Code | Size | Thickness | Pallet QTY |
|------------|--------------------------------|-----------|------------|
| QAU-EBC-01 | 1.2m x 1m (1.2m ²) | 9mm | 75 sheets |



E-Board Pro Underlay

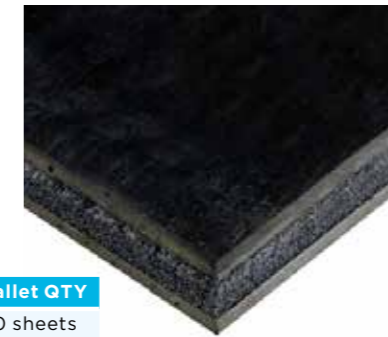

Available in

| Code | Size | Thickness | Pallet QTY |
|------------|--------------------------------|-----------|------------|
| QAU-EBP-01 | 1.2m x 1m (1.2m ²) | 15mm | 50 sheets |

Minimum order quantity 50 sheets / 1 pallet

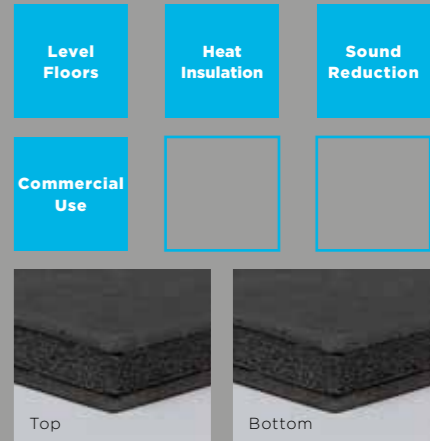



Acoustic Solutions Heavy Traffic

| Product | Density | Thickness | Impact Sound Reduction | Airborne Sound Insulation | Thermal Resistance |
|--------------------------------|-------------------|-----------|------------------------|---------------------------|--------------------|
| | kg/m ³ | mm | dB | dB | Tog Value |
| SoundBarrier | | 1 | 24 | | 0.4 |
| Regupol Sonus 3912 | 370 ± 5% | 6 | 23 | 53 | 0.49 |
| Regupol Sonus 4515 Multi 3mm | 420 ± 5% | 3 | 18 | | 0.39 |
| Regupol Sonus 4515 Multi 4.5mm | 420 ± 5% | 4.5 | 18 | | 0.54 |
| Regupol Sonus 4515 Eco 3mm | 470 ± 5% | 3 | 17 | | |
| Regupol Sonus 4515 Eco 4.5mm | 470 ± 5% | 4.5 | 18 | | |
| Quiet Cork 2mm | 250 ± 5% | 2 | 20 | | 0.3 |
| Quiet Cork 5mm | 250 ± 5% | 5 | 20 | | |
| E-Board Timber | | 12 | 22 | 49 | |
| E-Board Concrete | | 9 | 24 | 47 | |
| E-Board Pro | | 15 | 29 | 54 | |





High quality MDF free-floating floor levelling system.

Jumpax Basic is an extremely quick and cost-effective way to level your sub floor when compared with the traditional methods of screeding or ply boarding the sub floor.

Easy does it

With a 3mm base and 4mm top board bound by a special interactive adhesive, Jumpax Basic is quick, clean and easy to install compared with traditional screeds. It preserves the sub-floor and allows you to lay the finished floor covering quicker, saving you time.

Smooth, stable and simply warmer

The system is ideal for creating a sub-floor layer over underfloor heating systems for a perfect finish ready for the floor covering – with very low thermal resistance (0.7 tog) to really let heat through.

Lightening the load

The lightweight MDF material means Jumpax Basic is a breeze to lift and manoeuvre, so with its quick and easy installation you'll really save time and effort.

Impact sound reduction

Jumpax Basic has the added benefit of providing a sound reduction of 21dB (when installed over QA TechniBoard underlay) - See page 23.



Available in

| Code | Size | Thickness | Pallet QTY |
|------------|--|--|------------|
| QAU-JPB-01 | 4 upper, 4 lower panels (2.88m ²)/pack | 3mm upper, 4mm lower panels (7mm overal) | 48 |

| | | |
|----------------|-----------------|--------------------|
| Level Floors | Sound Reduction | Underfloor Heating |
| Commercial Use | | |
| Top | | Bottom |





Simply Better

Accessories

As a professional, these are the things you simply can't do without. The tools of your trade, the everyday items you rely on...

and you can rely on QA to have a complete range of quality accessories that give you great value too.



The NEW Matt Black Profiles

An attractive collection of popular profiles in a stylish matt black finish.





Standard Profiles Accessories

A range of quality silver and gold coloured screw-down profiles, sold in full box quantities, offering **superb** value.

Single Edge

Protects the carpet edge for a neat finish.

Available in

| Code | Length | Qty per carton | Colour |
|------------|--------|----------------|------------|
| QAA-SSE-S1 | 0.9m | 45 | Silver |
| QAA-SSE-G1 | 0.9m | 45 | Gold |
| QAA-SSE-B1 | 0.9m | 30 | Matt Black |
| QAA-SSE-S2 | 2.7m | 15 | Silver |
| QAA-SSE-G2 | 2.7m | 15 | Gold |
| QAA-SSE-B2 | 2.7m | 15 | Matt Black |

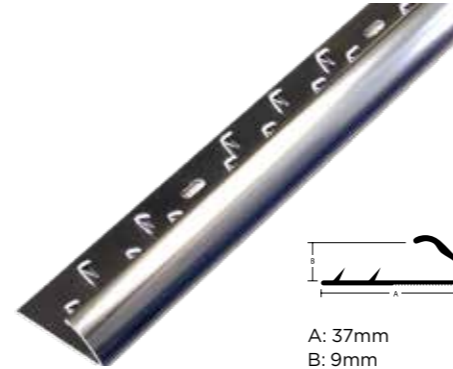

Cover Strip

Covers and protects on a wide range of floor coverings. Pleated and fluted - Colour matched fixing screws are included with the profiles for where the screw heads would be visible.

Available in

| Code | Length | Qty per carton | Colour |
|------------|--------|----------------|--------|
| QAA-SCS-S1 | 0.9m | 45 | Silver |
| QAA-SCS-G1 | 0.9m | 45 | Gold |
| QAA-SCS-S2 | 2.7m | 15 | Silver |
| QAA-SCS-G2 | 2.7m | 15 | Gold |



Carpet Cover Strip

Angled ribs underneath lock into the pile and pull the two carpets together as the strip's screwed to the floor. Suitable for all types of carpet. Colour matched fixing screws are included with the profiles for where the screw heads would be visible.

Available in

| Code | Length | Qty per carton | Colour |
|------------|--------|----------------|--------|
| QAA-SCC-S1 | 0.9m | 45 | Silver |
| QAA-SCC-G1 | 0.9m | 45 | Gold |
| QAA-SCC-S2 | 2.7m | 15 | Silver |
| QAA-SCC-G2 | 2.7m | 15 | Gold |

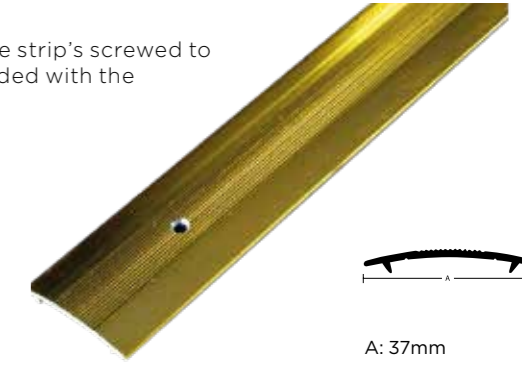

Dual Grip

For a tidy, protected join between two carpets.

Available in

| Code | Length | Qty per carton | Colour |
|------------|--------|----------------|------------|
| QAA-SDG-S1 | 0.9m | 45 | Silver |
| QAA-SDG-G1 | 0.9m | 45 | Gold |
| QAA-SDG-B1 | 0.9m | 30 | Matt Black |
| QAA-SDG-S2 | 2.7m | 15 | Silver |
| QAA-SDG-G2 | 2.7m | 15 | Gold |
| QAA-SDG-B2 | 2.7m | 15 | Matt Black |

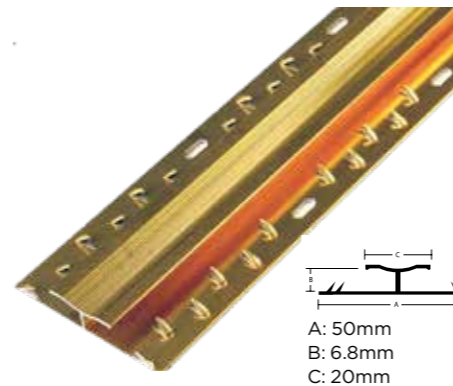

Extra Wide Cover Strip

Perfect for covering difficult joins between any floor coverings - one of the widest designs on the market. Colour matched fixing screws are included with the profiles for where the screw heads would be visible.

Available in

| Code | Length | Qty per carton | Colour |
|------------|--------|----------------|--------|
| QAA-SWC-S2 | 2.7m | 15 | Silver |
| QAA-SWC-G2 | 2.7m | 15 | Gold |

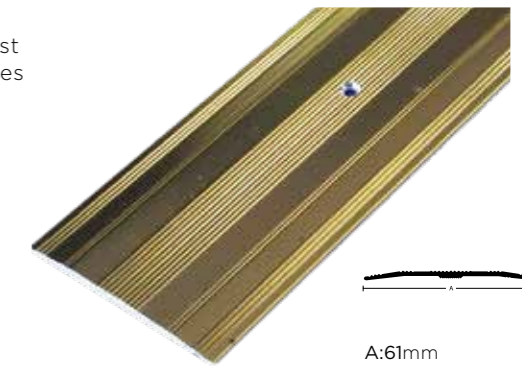

9mm Z Section

For a neat join where laminated smooth flooring meets carpet. Lightly tap on top of the strip with a rubber mallet after fitting for a snug fit to edges of floor coverings.

Available in

| Code | Length | Qty per carton | Colour |
|------------|--------|----------------|------------|
| QAA-SZS-S1 | 0.9m | 45 | Silver |
| QAA-SZS-G1 | 0.9m | 45 | Gold |
| QAA-SZS-B1 | 0.9m | 30 | Matt Black |
| QAA-SZS-S2 | 2.7m | 15 | Silver |
| QAA-SZS-G2 | 2.7m | 15 | Gold |
| QAA-SZS-B2 | 2.7m | 15 | Matt Black |

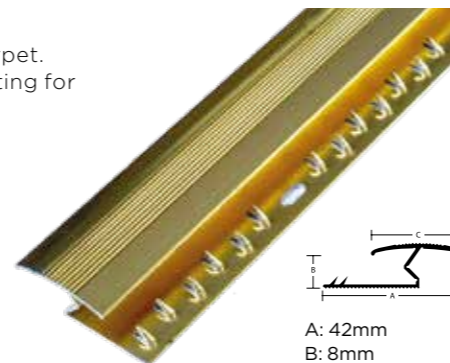

A: 42mm
B: 8mm
C: 28mm

14mm Z Section

A larger version of our Standard 9mm Z Section designed for thicker wood and carpet.

Available in

| Code | Length | Qty per carton | Colour |
|------------|--------|----------------|--------|
| QAA-SZP-S2 | 2.7m | 10 | Silver |
| QAA-SZP-G2 | 2.7m | 10 | Gold |

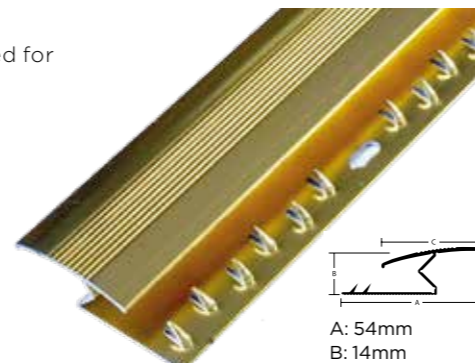

A: 54mm
B: 14mm
C: 40mm

Vinyl Edge

Neatens and protects the edge of resilient vinyl floor coverings up to 4mm thick. Colour matched fixing screws are included with the profiles for where the screw heads would be visible.

Available in

| Code | Length | Qty per carton | Colour |
|------------|--------|----------------|--------|
| QAA-SVE-S1 | 0.9m | 45 | Silver |
| QAA-SVE-G1 | 0.9m | 45 | Gold |
| QAA-SVE-S2 | 2.7m | 15 | Silver |
| QAA-SVE-G2 | 2.7m | 15 | Gold |

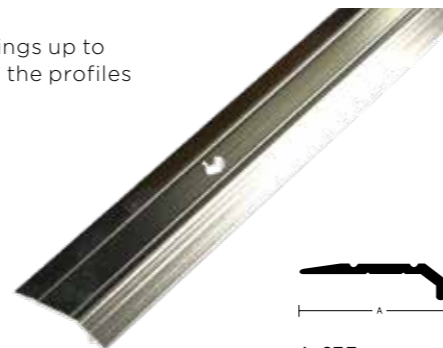

A: 27.7mm

QA Self Adhesive Profiles Accessories

A fantastic collection of silver and gold coloured profiles, sold in full boxes. All products are **self-adhesive** for faster fitting and convenience.

8mm Angle Edge

For a smooth join to resilient floor coverings. Quick and easy to install.

Available in

| Code | Length | Qty per carton | Colour |
|------------|--------|----------------|-------------|
| QAA-AAE-B1 | 0.9m | 30 | Matt Black |
| QAA-AAE-S2 | 2.7m | 10 | Matt Silver |
| QAA-AAE-G2 | 2.7m | 10 | Matt Gold |
| QAA-AAE-B2 | 2.7m | 10 | Matt Black |



A: 43mm
B: 8mm
C: 10mm

14mm Angle Edge

A 14mm version of the Self Adhesive 8mm Angle Edge.

Available in

| Code | Length | Qty per carton | Colour |
|------------|--------|----------------|-------------|
| QAA-AAN-S2 | 2.7m | 10 | Matt Silver |
| QAA-AAN-G2 | 2.7m | 10 | Matt Gold |



A: 43mm
B: 14.3mm
C: 16.3mm

20mm Angle Edge

The largest version of our Self Adhesive 8mm Angle Edge.

Available in

| Code | Length | Qty per carton | Colour |
|------------|--------|----------------|-------------|
| QAA-AAX-S2 | 2.7m | 10 | Matt Silver |
| QAA-AAX-G2 | 2.7m | 10 | Matt Gold |

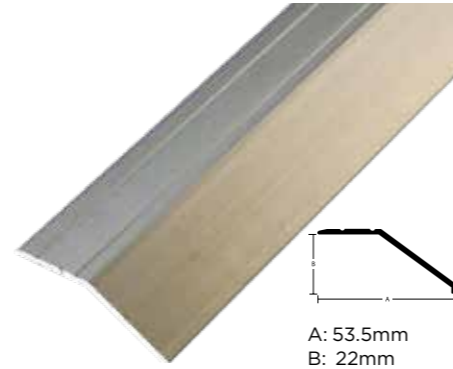

15mm Nosing

An ideal choice for wood/laminate, with the advantage of quick and easy self adhesive fixing.

Available in

| Code | Length | Qty per carton | Colour |
|------------|--------|----------------|-------------|
| QAA-ANX-S2 | 2.7m | 10 | Matt Silver |
| QAA-ANX-G2 | 2.7m | 10 | Matt Gold |

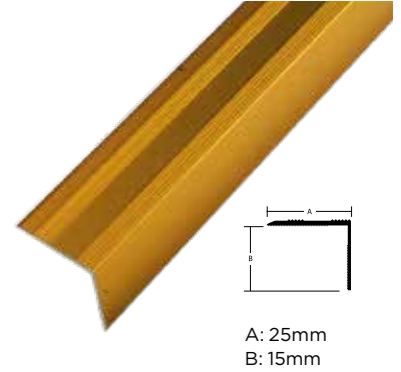

Euro Cover Strip

A high quality, easy to install cover strip for most floor coverings of equal level.

Available in

| Code | Length | Qty per carton | Colour |
|------------|--------|----------------|-------------|
| QAA-AEC-B1 | 0.9m | 30 | Matt Black |
| QAA-AEC-S2 | 2.7m | 10 | Matt Silver |
| QAA-AEC-G2 | 2.7m | 10 | Matt Gold |
| QAA-AEC-B2 | 2.7m | 10 | Matt Black |

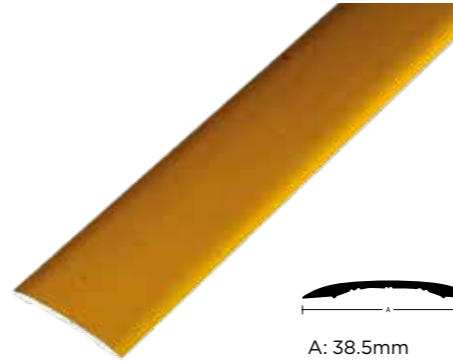

20mm Nosing

A larger version of our 9mm and 15mm Nosings.

Available in

| Code | Length | Qty per carton | Colour |
|------------|--------|----------------|-------------|
| QAA-ANZ-S2 | 2.7m | 10 | Matt Silver |
| QAA-ANZ-G2 | 2.7m | 10 | Matt Gold |

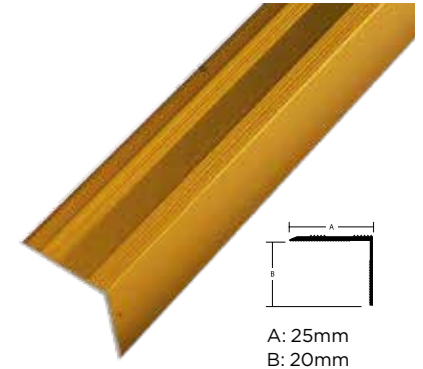

9mm Nosing

A quick and easy to use choice for wood/laminate. Ideal for a neat finish.

Available in

| Code | Length | Qty per carton | Colour |
|------------|--------|----------------|-------------|
| QAA-ANO-B1 | 0.9m | 30 | Matt Black |
| QAA-ANO-S2 | 2.7m | 10 | Matt Silver |
| QAA-ANO-G2 | 2.7m | 10 | Matt Gold |
| QAA-ANO-B2 | 2.7m | 10 | Matt Black |

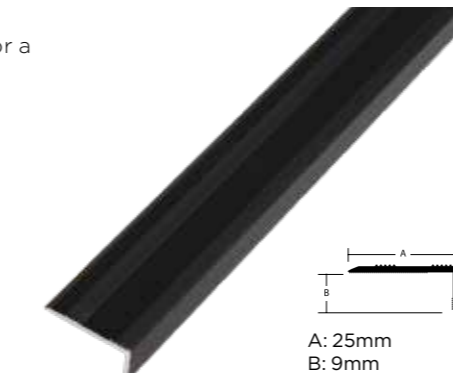



Specialist Profiles Accessories

Choose our Specialist range for fantastic quality combined with faster fitting. All profiles in this collection are **self-adhesive** and are available in either single lengths or full boxes. Offering a wide variety of wood colour options, with certified AC3 rating for scratch resistance, to provide the perfect solution for that finishing touch to a new floor.

2mm - 18mm Adjustable Ramp

Available in

| Code | Length | Qty per carton | Colour |
|------------|--------|----------------|----------------|
| QAA-FAR-01 | 0.9m | 15 | Brushed Steel |
| QAA-FAR-02 | 0.9m | 15 | Matt Silver |
| QAA-FAR-03 | 0.9m | 15 | Matt Gold |
| QAA-FAR-04 | 0.9m | 15 | Light Oak |
| QAA-FAR-05 | 0.9m | 15 | Dark Oak |
| QAA-FAR-06 | 0.9m | 15 | Country Oak |
| QAA-FAR-07 | 0.9m | 15 | Grey Oak |
| QAA-FAR-08 | 0.9m | 15 | Beige Grey Oak |
| QAA-FAR-09 | 0.9m | 15 | Tigua |
| QAA-FAR-10 | 0.9m | 15 | Oak Crème |
| QAA-FAR-11 | 0.9m | 15 | Light Grey Oak |
| QAA-FAR-12 | 0.9m | 15 | Walnut |

| Code | Length | Qty per carton | Colour |
|------------|--------|----------------|----------------|
| QAA-FAR-13 | 2.7m | 10 | Matt Silver |
| QAA-FAR-14 | 2.7m | 10 | Matt Gold |
| QAA-FAR-15 | 2.7m | 10 | Brushed Steel |
| QAA-FAR-16 | 2.7m | 10 | Light Oak |
| QAA-FAR-17 | 2.7m | 10 | Dark Oak |
| QAA-FAR-18 | 2.7m | 10 | Country Oak |
| QAA-FAR-19 | 2.7m | 10 | Grey Oak |
| QAA-FAR-20 | 2.7m | 10 | Beige Grey Oak |
| QAA-FAR-21 | 2.7m | 10 | Tigua |
| QAA-FAR-22 | 2.7m | 10 | Oak Crème |
| QAA-FAR-23 | 2.7m | 10 | Light Grey Oak |
| QAA-FAR-24 | 2.7m | 10 | Walnut |

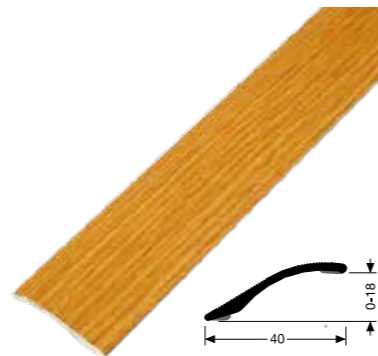
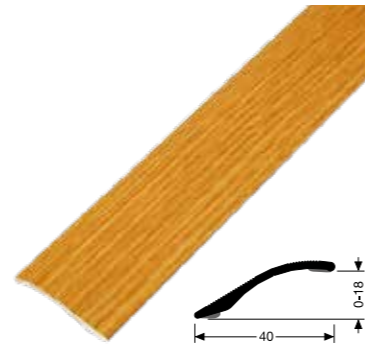

Cover Strip

Covers and protects on a wide range of floor coverings. Pleated and fluted.

Available in

| Code | Length | Qty per carton | Colour |
|------------|--------|----------------|----------------|
| QAA-FCS-01 | 0.9m | 15 | Matt Silver |
| QAA-FCS-02 | 0.9m | 15 | Matt Gold |
| QAA-FCS-03 | 0.9m | 15 | Light Oak |
| QAA-FCS-04 | 0.9m | 15 | Dark Oak |
| QAA-FCS-05 | 0.9m | 15 | Country Oak |
| QAA-FCS-06 | 0.9m | 15 | Grey Oak |
| QAA-FCS-07 | 0.9m | 15 | Beige Grey Oak |
| QAA-FCS-08 | 0.9m | 15 | Tigua |
| QAA-FCS-09 | 0.9m | 15 | Oak Crème |
| QAA-FCS-10 | 0.9m | 15 | Light Grey Oak |
| QAA-FCS-11 | 0.9m | 15 | Walnut |
| QAA-FCS-23 | 0.9m | 15 | Brushed Steel |

| Code | Length | Qty per carton | Colour |
|------------|--------|----------------|----------------|
| QAA-FCS-12 | 2.7m | 10 | Matt Silver |
| QAA-FCS-13 | 2.7m | 10 | Matt Gold |
| QAA-FCS-14 | 2.7m | 10 | Light Oak |
| QAA-FCS-15 | 2.7m | 10 | Dark Oak |
| QAA-FCS-16 | 2.7m | 10 | Country Oak |
| QAA-FCS-17 | 2.7m | 10 | Grey Oak |
| QAA-FCS-18 | 2.7m | 10 | Beige Grey Oak |
| QAA-FCS-19 | 2.7m | 10 | Tigua |
| QAA-FCS-20 | 2.7m | 10 | Oak Crème |
| QAA-FCS-21 | 2.7m | 10 | Light Grey Oak |
| QAA-FCS-22 | 2.7m | 10 | Walnut |
| QAA-FCS-24 | 2.7m | 10 | Brushed Steel |

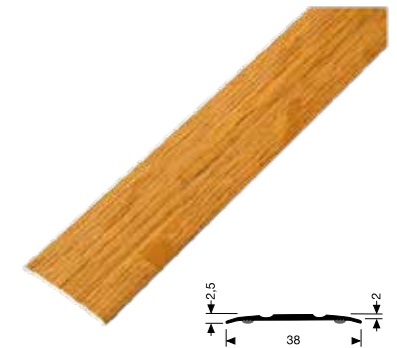
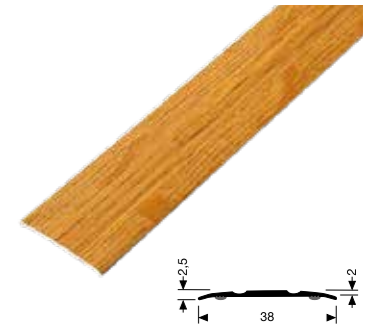

10mm End Section

Available in

| Code | Length | Qty per carton | Colour |
|------------|--------|----------------|----------------|
| QAA-FES-01 | 0.9m | 15 | Matt Silver |
| QAA-FES-02 | 0.9m | 15 | Matt Gold |
| QAA-FES-03 | 0.9m | 15 | Brushed Steel |
| QAA-FES-04 | 0.9m | 15 | Light Oak |
| QAA-FES-05 | 0.9m | 15 | Dark Oak |
| QAA-FES-06 | 0.9m | 15 | Country Oak |
| QAA-FES-07 | 0.9m | 15 | Grey Oak |
| QAA-FES-08 | 0.9m | 15 | Beige Grey Oak |
| QAA-FES-09 | 0.9m | 15 | Tigua |
| QAA-FES-10 | 0.9m | 15 | Oak Crème |
| QAA-FES-11 | 0.9m | 15 | Light Grey Oak |
| QAA-FES-12 | 0.9m | 15 | Walnut |

| Code | Length | Qty per carton | Colour |
|------------|--------|----------------|----------------|
| QAA-FES-13 | 2.7m | 10 | Matt Silver |
| QAA-FES-14 | 2.7m | 10 | Matt Gold |
| QAA-FES-15 | 2.7m | 10 | Brushed Steel |
| QAA-FES-16 | 2.7m | 10 | Light Oak |
| QAA-FES-17 | 2.7m | 10 | Dark Oak |
| QAA-FES-18 | 2.7m | 10 | Country Oak |
| QAA-FES-19 | 2.7m | 10 | Grey Oak |
| QAA-FES-20 | 2.7m | 10 | Beige Grey Oak |
| QAA-FES-21 | 2.7m | 10 | Tigua |
| QAA-FES-22 | 2.7m | 10 | Oak Crème |
| QAA-FES-23 | 2.7m | 10 | Light Grey Oak |
| QAA-FES-24 | 2.7m | 10 | Walnut |

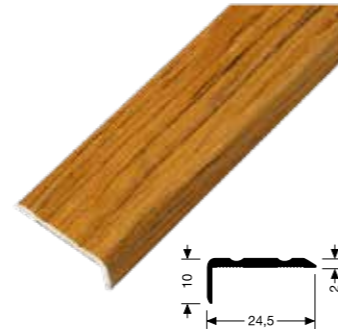
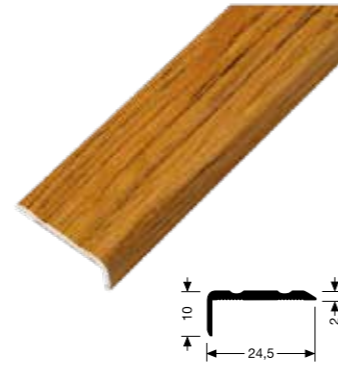

20mm Stair Nosing

Available in

| Code | Length | Qty per carton | Colour |
|------------|--------|----------------|----------------|
| QAA-FSN-01 | 0.9m | 15 | Matt Silver |
| QAA-FSN-02 | 0.9m | 15 | Matt Gold |
| QAA-FSN-03 | 0.9m | 15 | Brushed Steel |
| QAA-FSN-04 | 0.9m | 15 | Light Oak |
| QAA-FSN-05 | 0.9m | 15 | Dark Oak |
| QAA-FSN-06 | 0.9m | 15 | Country Oak |
| QAA-FSN-07 | 0.9m | 15 | Grey Oak |
| QAA-FSN-08 | 0.9m | 15 | Beige Grey Oak |
| QAA-FSN-09 | 0.9m | 15 | Tigua |
| QAA-FSN-10 | 0.9m | 15 | Oak Crème |
| QAA-FSN-11 | 0.9m | 15 | Light Grey Oak |
| QAA-FSN-12 | 0.9m | 15 | Walnut |

| Code | Length | Qty per carton | Colour |
|------------|--------|----------------|----------------|
| QAA-FSN-15 | 2.7m | 10 | Matt Silver |
| QAA-FSN-13 | 2.7m | 10 | Matt Gold |
| QAA-FSN-14 | 2.7m | 10 | Brushed Steel |
| QAA-FSN-16 | 2.7m | 10 | Light Oak |
| QAA-FSN-17 | 2.7m | 10 | Dark Oak |
| QAA-FSN-18 | 2.7m | 10 | Country Oak |
| QAA-FSN-19 | 2.7m | 10 | Beige Grey Oak |
| QAA-FSN-20 | 2.7m | 10 | Tigua |
| QAA-FSN-21 | 2.7m | 10 | Oak Crème |
| QAA-FSN-22 | 2.7m | 10 | Light Grey Oak |
| QAA-FSN-23 | 2.7m | 10 | Grey Oak |
| QAA-FSN-24 | 2.7m | 10 | Walnut |

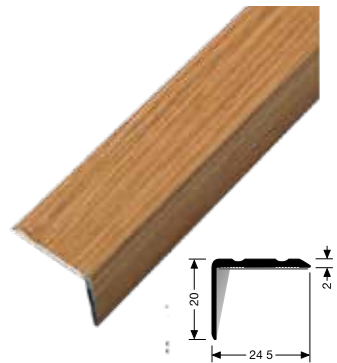
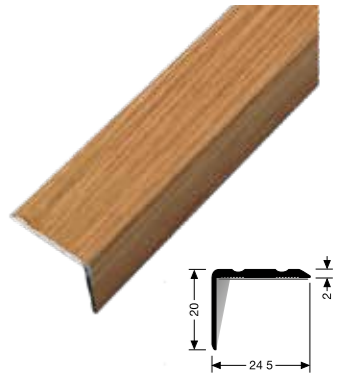

Z Section

For a neat join where laminated smooth flooring meets carpet. Lightly tap on top of the strip with a rubber mallet after fitting for a snug fit to edges of floor coverings.

Available in

| Code | Length | Qty per carton | Colour |
|------------|--------|----------------|----------------|
| QAA-FZS-01 | 0.9m | 15 | Matt Silver |
| QAA-FZS-02 | 0.9m | 15 | Matt Gold |
| QAA-FZS-03 | 0.9m | 15 | Brushed Steel |
| QAA-FZS-04 | 0.9m | 15 | Light Oak |
| QAA-FZS-05 | 0.9m | 15 | Dark Oak |
| QAA-FZS-06 | 0.9m | 15 | Country Oak |
| QAA-FZS-07 | 0.9m | 15 | Grey Oak |
| QAA-FZS-08 | 0.9m | 15 | Light Grey Oak |
| QAA-FZS-09 | 0.9m | 15 | Walnut |
| QAA-FZS-19 | 0.9m | 15 | Beige Grey Oak |
| QAA-FZS-21 | 0.9m | 15 | Tigua |
| QAA-FZS-23 | 0.9m | 15 | Oak Crème |

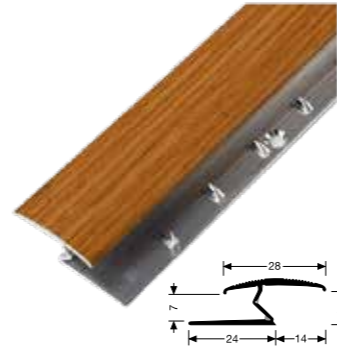

| Code | Length | Qty per carton | Colour |
|------------|--------|----------------|----------------|
| QAA-FZS-10 | 2.7m | 10 | Matt Silver |
| QAA-FZS-11 | 2.7m | 10 | Matt Gold |
| QAA-FZS-12 | 2.7m | 10 | Brushed Steel |
| QAA-FZS-13 | 2.7m | 10 | Light Oak |
| QAA-FZS-14 | 2.7m | 10 | Dark Oak |
| QAA-FZS-15 | 2.7m | 10 | Country Oak |
| QAA-FZS-16 | 2.7m | 10 | Grey Oak |
| QAA-FZS-17 | 2.7m | 10 | Light Grey Oak |
| QAA-FZS-18 | 2.7m | 10 | Walnut |
| QAA-FZS-20 | 2.7m | 10 | Beige Grey Oak |
| QAA-FZS-22 | 2.7m | 10 | Tigua |
| QAA-FZS-24 | 2.7m | 10 | Oak Crème |

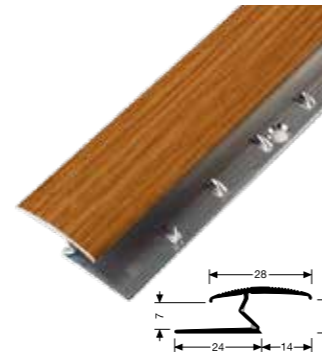

DISPLAY STANDS



Dimensions:
Height: 1.6m
Width: 0.62m
Depth: 0.62m

- 33 hooks (20cm)
10 lengths per hook



Dimensions:
Height: 1.6m
Width: 0.62m
Depth: 0.62m

- 18 hooks
holds 10-15 tubes

Premium Profiles

Add that extra touch of finesse to your installations with our range of exquisite **Premium Profiles** available in Chrome, Black Nickel and Brushed finishes.

QA Premium Profiles Accessories

Superior quality, premium finish profiles for **luxury** installations that require the best. Available in a selection of indulgent metal colour options - Chrome, Black Nickel and Brushed - and a combination of screw down and self-adhesive applications.

Dual Grip

Screw down fixture for a tidy, protected join between two carpets. Only available in tubes of 5 lengths.



Avai

| Code | Length | Qty per carton | Colour |
|------------|--------|----------------|--------------|
| QAA-PDG-01 | 0.9m | 5 | Chrome |
| QAA-PDG-02 | 2.7m | 5 | Chrome |
| QAA-PDG-03 | 0.9m | 5 | Black Nickel |
| QAA-PDG-04 | 2.7m | 5 | Black Nickel |
| QAA-PDG-05 | 0.9m | 5 | Brushed |
| QAA-PDG-06 | 2.7m | 5 | Brushed |

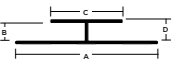

A: 60mm
B: 8mm
C: 30mm
D: 10mm

Single Edge

Screw down fixture - Protects the carpet edge for a neat finish. Only available in tubes of 5 lengths.



Available in

| Code | Length | Qty per carton | Colour |
|------------|--------|----------------|--------------|
| QAA-PSE-01 | 0.9m | 5 | Chrome |
| QAA-PSE-02 | 2.7m | 5 | Chrome |
| QAA-PSE-03 | 0.9m | 5 | Black Nickel |
| QAA-PSE-04 | 2.7m | 5 | Black Nickel |
| QAA-PSE-05 | 0.9m | 5 | Brushed |
| QAA-PSE-06 | 2.7m | 5 | Brushed |

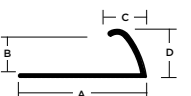

A: 40mm
B: 12mm
C: 11.9mm
D: 15mm



Adjustable Ramp

Self-adhesive fixture used to conceal height differences between two floor coverings. Only available in tubes of 5 lengths.

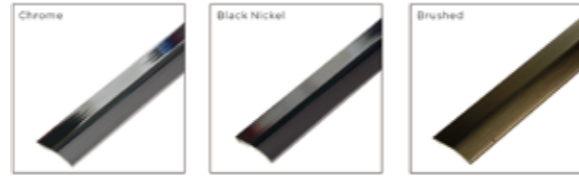

Available in

| Code | Length | Qty per carton | Colour |
|------------|--------|----------------|--------------|
| QAA-PAR-01 | 0.9m | 5 | Chrome |
| QAA-PAR-02 | 2.7m | 5 | Chrome |
| QAA-PAR-03 | 0.9m | 5 | Black Nickel |
| QAA-PAR-04 | 2.7m | 5 | Black Nickel |
| QAA-PAR-05 | 0.9m | 5 | Brushed |
| QAA-PAR-06 | 2.7m | 5 | Brushed |

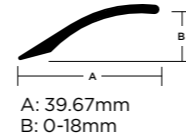

Z-Section

Screw down fixture for a neat join where laminated smooth flooring meets carpet. Lightly tap on top of the strip with a rubber mallet after fitting for a snug fit to edges of floor coverings. Only available in tubes of 5 lengths.



Available in

| Code | Length | Qty per carton | Colour |
|------------|--------|----------------|--------------|
| QAA-PZS-01 | 0.9m | 5 | Chrome |
| QAA-PZS-02 | 2.7m | 5 | Chrome |
| QAA-PZS-03 | 0.9m | 5 | Black Nickel |
| QAA-PZS-04 | 2.7m | 5 | Black Nickel |
| QAA-PZS-05 | 0.9m | 5 | Brushed |
| QAA-PZS-06 | 2.7m | 5 | Brushed |

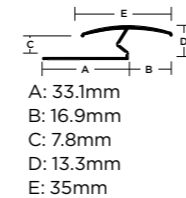

Euro Cover Strip

Self adhesive fixture - A high quality, easy to install cover strip for most floor coverings of equal level. Only available in tubes of 5 lengths.

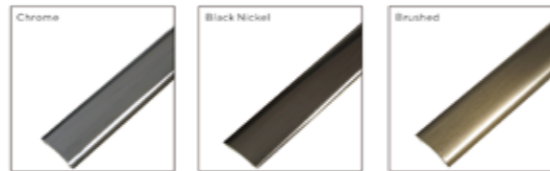

Available in

| Code | Length | Qty per carton | Colour |
|------------|--------|----------------|--------------|
| QAA-PEC-01 | 0.9m | 5 | Chrome |
| QAA-PEC-02 | 2.7m | 5 | Chrome |
| QAA-PEC-03 | 0.9m | 5 | Black Nickel |
| QAA-PEC-04 | 2.7m | 5 | Black Nickel |
| QAA-PEC-05 | 0.9m | 5 | Brushed |
| QAA-PEC-06 | 2.7m | 5 | Brushed |

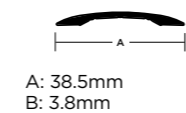

Simply Better

Our sample display boards are the perfect way to show your customers the quality and finish of the profiles available to them.

Contact your Account Manager or our Customer Service Team to request one for your store.

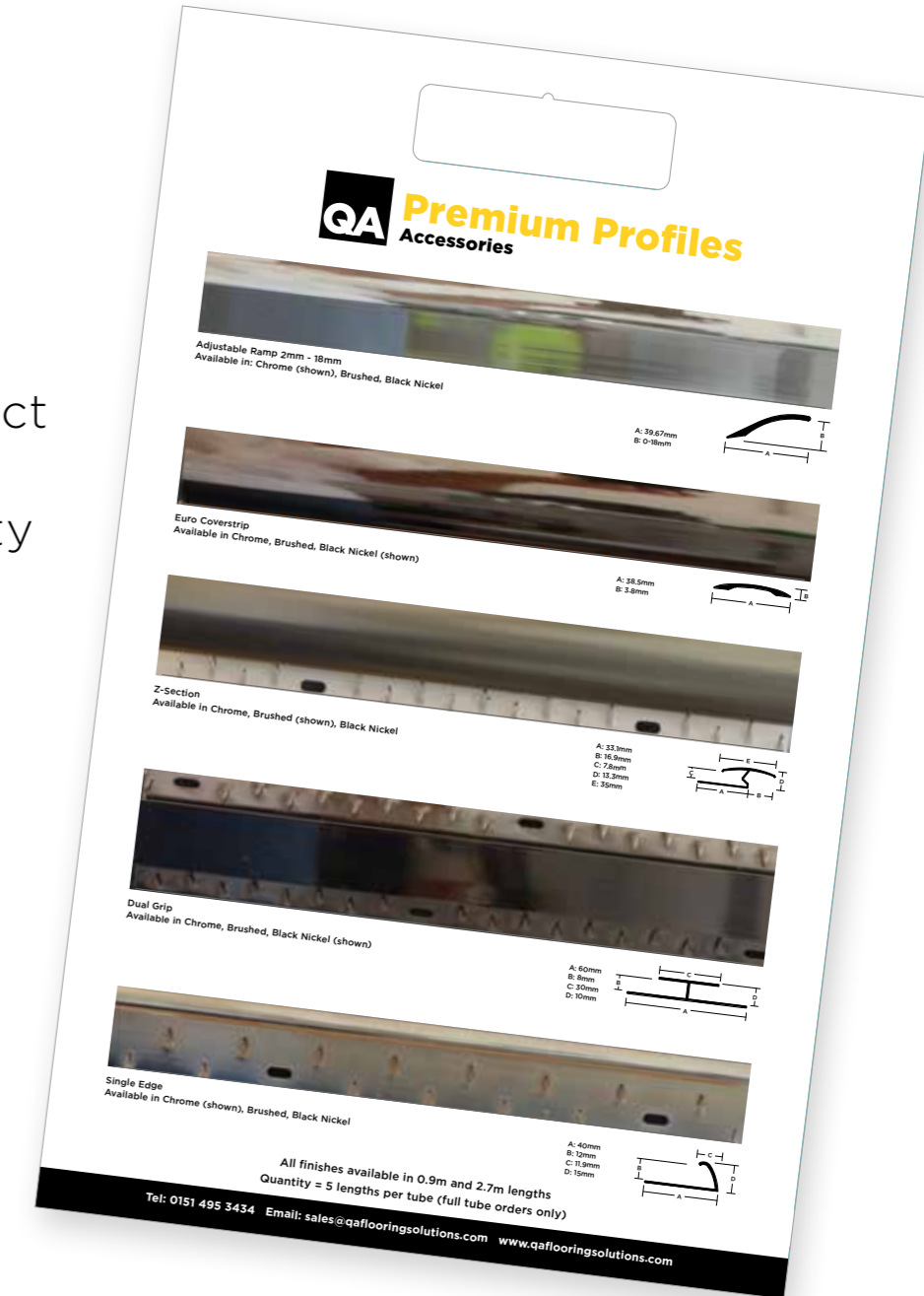



Scotia

Bridges the expansion gaps on laminate, engineered, and solid wood floors for a truly **professional finish**.

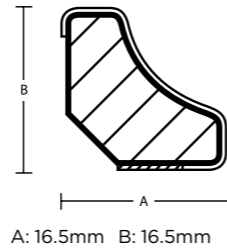
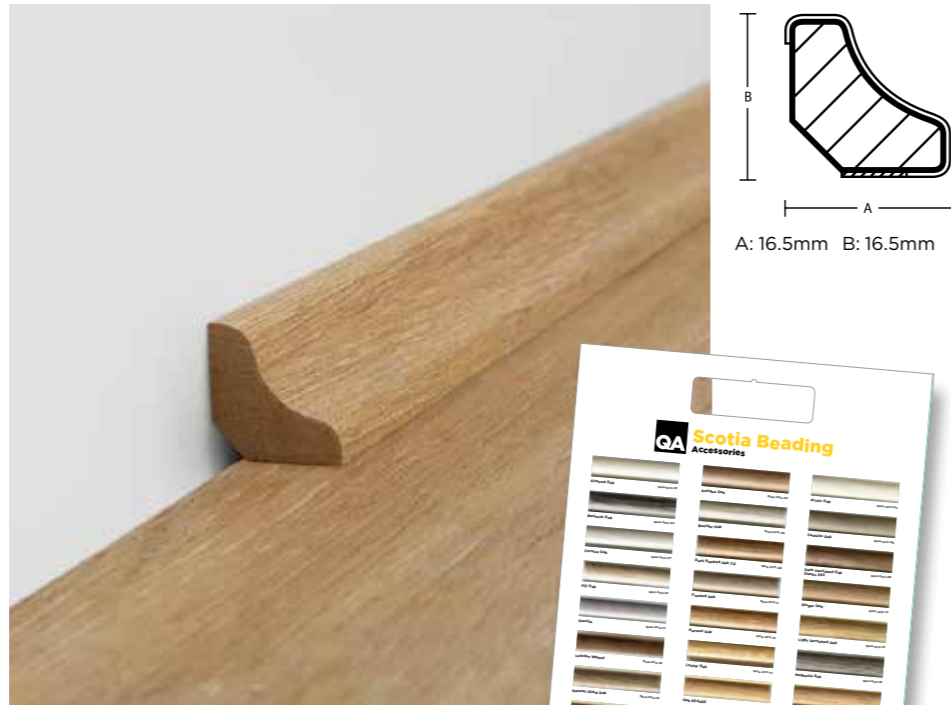

Available in

| Product Code | Length | Qty per carton | Colour |
|--------------|--------|----------------|-------------------------------|
| QAA-SCH-01 | 2.4m | 50 | Almond Oak |
| QAA-SCH-02 | 2.4m | 50 | Antique Oak |
| QAA-SCH-03 | 2.4m | 50 | Arctic Oak |
| QAA-SCH-04 | 2.4m | 50 | Bedrock Oak |
| QAA-SCH-05 | 2.4m | 50 | Boulder Oak |
| QAA-SCH-06 | 2.4m | 50 | Castello Oak |
| QAA-SCH-07 | 2.4m | 50 | Corsica Oak |
| QAA-SCH-08 | 2.4m | 50 | Dark Planked Oak 112 |
| QAA-SCH-09 | 2.4m | 50 | Dark Varnished Oak Planks 293 |
| QAA-SCH-10 | 2.4m | 50 | Fiji Oak |
| QAA-SCH-11 | 2.4m | 50 | Frosted Oak |
| QAA-SCH-12 | 2.4m | 50 | Ginger Oak |
| QAA-SCH-13 | 2.4m | 50 | Granite |
| QAA-SCH-14 | 2.4m | 50 | Harvest Oak |
| QAA-SCH-15 | 2.4m | 50 | Light Varnished Oak |
| QAA-SCH-16 | 2.4m | 50 | Lofoten Walnut |
| QAA-SCH-17 | 2.4m | 50 | Loxley Oak |
| QAA-SCH-18 | 2.4m | 50 | Magnolia Oak |
| QAA-SCH-19 | 2.4m | 50 | Natural Oiled Oak |
| QAA-SCH-20 | 2.4m | 50 | Oak 654493 |
| QAA-SCH-21 | 2.4m | 50 | Oak FOE103 |
| QAA-SCH-22 | 2.4m | 50 | Oak FOE1032 |
| QAA-SCH-23 | 2.4m | 50 | Old Grey Planked Oak |
| QAA-SCH-24 | 2.4m | 50 | Poppy Oak |
| QAA-SCH-25 | 2.4m | 50 | Prestige Oak |
| QAA-SCH-26 | 2.4m | 50 | Slate |
| QAA-SCH-27 | 2.4m | 50 | Titanium Oak |
| QAA-SCH-28 | 2.4m | 50 | Varnished White Oak |
| QAA-SCH-29 | 2.4m | 50 | Virginia Chestnut |
| QAA-SCH-30 | 2.4m | 50 | Virginia Walnut |
| QAA-SCH-31 | 2.4m | 50 | White |
| QAA-SCH-32 | 2.4m | 50 | White Oak |
| QAA-SCH-33 | 2.4m | 50 | Worn Oak |
| QAA-SCH-34 | 2.4m | 50 | Washed Grey Oak |
| QAA-SCH-35 | 2.4m | 50 | Walnut |
| QAA-SCH-36 | 2.4m | 50 | Washed Light Grey |

Did You Know?

You can paint our White Scotia (QAA-SCH-31) any colour you choose to match the colour of your skirting boards.





Standard Gripper Accessories

QA Standard Gripper offers high-quality performance with variants to suit every carpet and subfloor, domestic and contract use. With a pronounced bevel edge for an easy and consistent roll edge finish, it's made from high quality 6.5mm deep x 20mm wide 5-ply plywood with zinc plated nails and galvanised pins - giving exceptional carpet holding strength.

3 Floor Nail Specifications

Dual Purpose Nail, Concrete Nail, Wood Nail Gripper. 2 Pin Heights. Short Pin 3.2mm (1/8") - for cord carpeting and some low tuft carpets. Medium Pin 4.8mm (3/6") - the more usual pin length, suitable for most types of carpet.

Standard Dual Purpose Gripper

Pre-nailed with dual purpose nails for wood and concrete subfloors.

Standard Concrete Nail Gripper

Pre-nailed with masonry nails, specially designed for ease and speed of installation and an exceptionally strong fixing on concrete subfloors.

Standard Wood Nail Gripper

Pre-nailed with specially tempered nails (threaded for ultimate holding power), for easy, fast installation on board and suspended timber subfloors.

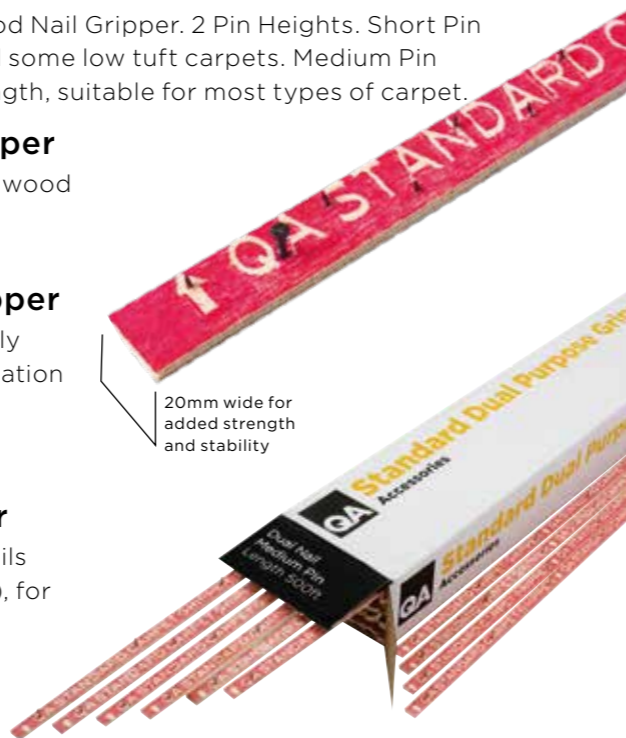

20mm wide for added strength and stability

Available in

| Code | Nail | Pin Height | Size | Boxed | Pallet QTY |
|------------|----------|------------|------|-----------|-----------------|
| QAA-GST-DS | Dual | Short | 5ft | 500ft/box | 50 boxes/pallet |
| QAA-GST-DN | Dual | Medium | 5ft | 500ft/box | 50 boxes/pallet |
| QAA-GST-CN | Concrete | Medium | 5ft | 500ft/box | 50 boxes/pallet |
| QAA-GST-WN | Wood | Medium | 5ft | 500ft/box | 50 boxes/pallet |



Premium Gripper Accessories

Rated **the best** by fitters.

Premium Gripper from QA Flooring Solutions is regarded by many fitters as their favourite choice when it comes to using a top-of-the-range gripper product. QA Premium Gripper is suitable for all types of luxury carpet installation and is ideal for high quality carpets. QA Premium Gripper has 50% more pins per length than our QA Standard Gripper and is 6.5mm deep x 30mm wide - giving better strength and stability so you can be sure that the installation will be perfect and trouble free every time. QA Premium Gripper is available in all nail options - dual purpose, wood and concrete. It comes in 5ft lengths and 400ft per box.

Premium Dual Purpose Gripper

Pre-nailed with dual purpose nails for wood and concrete subfloors.

Premium Concrete Nail Gripper

Pre-nailed with masonry nails, specially designed for ease and speed of installation and an exceptionally strong fixing on concrete subfloors.

Premium Wood Nail Gripper

Pre-nailed with specially tempered nails (threaded for ultimate holding power), for easy, fast installation on board and suspended timber subfloors.



30mm wide for added strength and stability



Available in

| Code | Nail | Pin Height | Size | Boxed | Pallet QTY |
|------------|----------|------------|------|-----------|-----------------|
| QAA-GPR-DN | Dual | Medium | 5ft | 400ft/box | 40 boxes/pallet |
| QAA-GPR-WN | Wood | Medium | 5ft | 400ft/box | 40 boxes/pallet |
| QAA-GPR-CN | Concrete | Medium | 5ft | 400ft/box | 40 boxes/pallet |





A **choice** of adhesives for a variety of different applications.

Heavy Duty Spray Adhesive

Suitable for most flooring applications including carpets, carpet tiles, underlays and textiles. Sticks to timber, chipboard, ceramic, stone, concrete, masonry, metals, most plastics, glass and rubber.



Available in

| Code | Can Content | Box Quantity | Pallet QTY |
|------------|-------------|--------------|------------|
| QAA-ADH-SA | 500ml | 12 cans | 144 boxes |

Strong Grip Gripper Adhesive

A high quality, gunnable adhesive – ideal for gap filling, fixing stair nosings, door strips and carpet grippers to most flooring surfaces and refitting skirting boards and covings. The approximate curing time is 24 hours.



Available in

| Code | Can Content | Box Quantity | Pallet QTY |
|------------|-------------|--------------|------------|
| QAA-ADH-GA | 350ml | 12 tubes | 48 boxes |

Fast Set Super Gripper Adhesive

A powerful, fast-setting, polyurethane adhesive ideal for fixing stair nosings, door strips, and carpet grippers to most floor surfaces. Exceptionally fast initial grab, with skin formation time of approx 3 minutes and a setting time of 8 to 10 minutes.



Available in

| Code | Can Content | Box Quantity | Pallet QTY |
|------------|-------------|--------------|------------|
| QAA-ADH-FG | 310ml | 12 tubes | 48 boxes |



Our Tapes are specially designed to give a strong, stable fixing that exceeds **British Standards** for various types of carpets and installations.

Gold Heatseam Tape

Perfect for conventional woven or secondary jute back carpets in light traffic areas – the metallised gold foil backing reduces heat loss into the floor, melting the adhesive more rapidly for faster seaming. It also slows down adhesive cooling giving you more time for pattern matching and allowing better control at lower temperatures for sensitive carpet piles and backings.



Available in

| Code | Size | Box QTY |
|------------|---------------|----------|
| QAA-TAP-GO | 101.6mm x 20m | 10 rolls |

Double Sided Tape

Heavy duty double sided tape for securing felt backed carpets and other floor coverings.



Available in

| Code | Size | Box QTY |
|------------|------------|----------|
| QAA-TAP-DS | 50mm x 50m | 24 rolls |

Anti Plas Tape

Special double sided tape for vinyl flooring that doesn't allow adhesive from the tape to transfer to the vinyl (unlike standard Double Sided Tape).



Available in

| Code | Size | Box QTY |
|------------|------------|----------|
| QAA-TAP-AP | 50mm x 50m | 24 rolls |



Vapour Tape

A self adhesive seaming tape that creates an effective moisture barrier with improved joint seal protection and also strengthens underlay joints.

Available in

| Code | Size | Box QTY |
|------------|------------|----------|
| QAA-TAP-VA | 75mm x 25m | 20 rolls |



Barrier Jointing Tape

A jointing tape that can be used with the Barrier wood underlays for added joint seal protection and also giving the underlay extra strength and stability.

Available in

| Code | Size | Box QTY |
|------------|------------|----------|
| QAA-TAP-BA | 50mm x 15m | 50 rolls |



Tools - General Purpose Accessories

A range of **premium quality tools** for everyday general use.

Shark Knife

A general purpose safety knife featuring ergonomic hand protection and easy blade access. Comes complete with strong plastic holster and belt clip.

Available in

| Code |
|------------|
| QAA-TOG-DK |



Steel Blades

Packed in strong plastic boxes for extra safety.

Available in

| Code | Type | Box QTY |
|------------|--------------------------|-------------|
| QAA-TOG-HD | Heavy Duty Straight Edge | 100 per box |
| QAA-TOG-HO | Hooked | 100 per box |
| QAA-TOG-CO | Concave | 100 per box |





Paper & Polythene Accessories

QA Bitumen Paper

A moisture resistant building paper which meets the requirements of BS 152 Class A1F. Typically used to protect against draught and damp, it is ideal for use underneath a nail down timber floor when installing directly to a timber floor.



Available in

| Code | Size |
|------------|------------------------------|
| QAA-FPA-KU | 1m x 25m (25m ²) |

Small Damp-Proof Polythene Membrane

Highly resistant to puncturing and suitable for use with underfloor heating systems, this protects against damp from concrete subfloors. It can be used either as an oversite membrane between a blinded hardcore bed and base concrete, or as a sandwich membrane in base concrete or between it and the screed.



Available in

| Code | Size | Gauge | Pack Quantity | Pallet QTY |
|------------|-----------------------------|-------|---------------|------------|
| QAA-DPM-SC | 2m x 5m (10m ²) | 1000G | 1 | 100 |

Large Damp-Proof Polythene Membrane

Highly resistant to puncturing and suitable for use with underfloor heating systems, this protects against damp from concrete subfloors. It can be used either as an oversite membrane between a blinded hardcore bed and base concrete, or as a sandwich membrane in base concrete or between it and the screed.



Available in

| Code | Size | Gauge | Pack Quantity | Pallet QTY |
|------------|-------------------------------|-------|---------------|------------|
| QAA-DPM-LC | 4m x 25m (100m ²) | 1000G | 1 | 40 |

Water Vapour Barrier

The perfect extra protection under wood flooring, this puncture-resistant barrier comes in a handy multifold pack and can be used with underfloor heating systems.



Available in

| Code | Size | Gauge | Pack Quantity | Pallet QTY |
|------------|-----------------------------|-------|---------------|------------|
| QAA-DPM-VB | 5m x 4m (20m ²) | 600G | 5 per Box | 180 Packs |





QA Flooring Solutions Ltd

Unit 2, Hurricane Drive, Liverpool, L24 8RL.

Tel: 0151 495 3434

Fax: 0151 427 0484

Email: sales@qaflooringsolutions.com

www.qaflooringsolutions.com